



## Instrumente für die Neurochirurgie

Instruments for Neurosurgery

Instrumentos para la neurocirugía

Instrumentes pour la neurochirurgie

Strumenti per la neurochirurgia

---

**Wundspreizer, selbsthaltend**

Self-Retaining Retractors  
 Separadores autostáticos  
 Ecarteurs autostatiques  
 Divaricatori autostatici



▶ **21-0147**  
5,0 cm, 2"

spitz  
sharp  
agudo  
pointu  
acuto



▶ **21-0148**  
7,0 cm, 2 3/4"

spitz  
sharp  
agudo  
pointu  
acuto



▶ **21-0149**  
7,0 cm, 2 3/4"

spitz  
sharp  
agudo  
pointu  
acuto

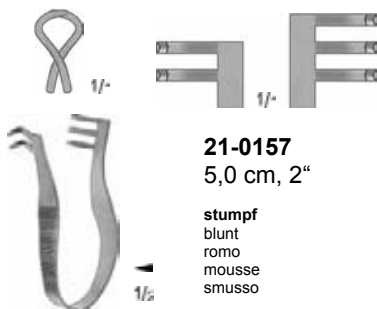

**21-0157**  
5,0 cm, 2"

stumpf  
blunt  
romo  
mousse  
smusso



**21-0158**  
7,0 cm, 2 3/4"

stumpf  
blunt  
romo  
mousse  
smusso

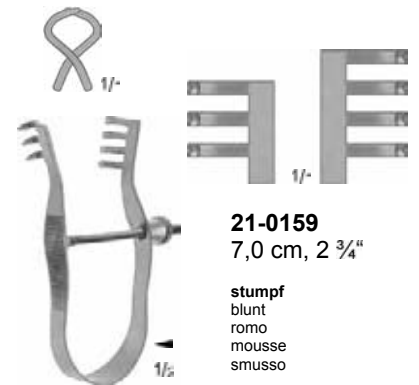

**21-0159**  
7,0 cm, 2 3/4"

stumpf  
blunt  
romo  
mousse  
smusso

FINSEN  
21-0147  
- 21-0157

FINSEN  
21-0148  
- 21-0158

FINSEN  
21-0149  
- 21-0159

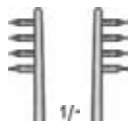

▶ **21-0150**  
7,0 cm, 2 3/4"

spitz  
sharp  
agudo  
pointu  
acuto

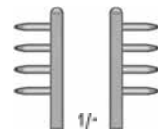

▶ **21-0152**  
10,0 cm, 4"

spitz  
sharp  
agudo  
pointu  
acuto

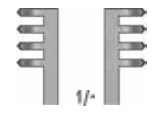

▶ **21-0155**  
10,0 cm, 4"

spitz  
sharp  
agudo  
pointu  
acuto



**21-0151**  
7,0 cm, 2 3/4"

stumpf  
blunt  
romo  
mousse  
smusso

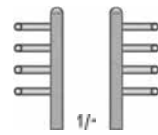

**21-0153**  
10,0 cm, 4"

stumpf  
blunt  
romo  
mousse  
smusso

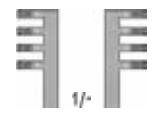

**21-0156**  
10,0 cm, 4"

stumpf  
blunt  
romo  
mousse  
smusso

ALM  
21-0150  
- 21-0151

ALM  
21-0152  
- 21-0153

ALM  
21-0155  
- 21-0156

7\ Ubj YXk N N Y89AC J9FG=CB cZ7 58! ?5G'D8 : 9Xlcf fl hd. #k k k 'WX Ug'Wa r'  
 H l'hl hcb mUddYUg' b'N YXYa e' j Yfglcb" H l'hl hcb mUddYUg' b'N YXYa e' j YX'k N N YZ " j Yfglcb"  
 7\ Ubj YXk N N Y89AC J9FG=CB cZ7 58! ?5G'D8 : 9Xlcf fl hd. #k k k 'WX Ug'Wa r'  
 H l'hl hcb mUddYUg' b'N YXYa e' j Yfglcb" H l'hl hcb mUddYUg' b'N YXYa e' j YX'k N N YZ " j Yfglcb"  
 7\ Ubj YXk N N Y89AC J9FG=CB cZ7 58! ?5G'D8 : 9Xlcf fl hd. #k k k 'WX Ug'Wa r'



**Wundspreizer, selbsthaltend**

Self-Retaining Retractors  
 Separadores autostáticos  
 Ecarteurs autostatiques  
 Divaricatori autostatici

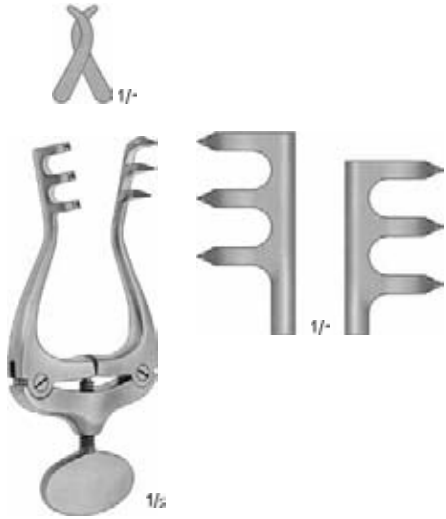

**JANSEN**  
**66-0700**  
 10,0 cm, 4"

spitz  
 sharp  
 agudo  
 pointu  
 acuto

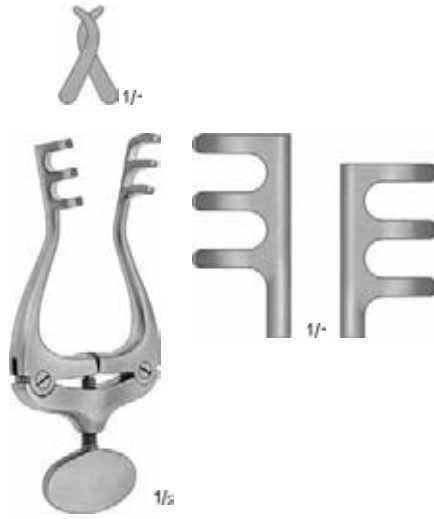

**JANSEN**  
**66-0701**  
 10,0 cm, 4"

stumpf  
 blunt  
 romo  
 mousse  
 smusso

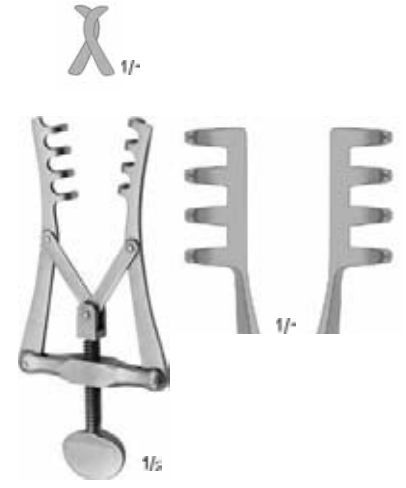

**ALLPORT**  
**66-0730**  
 10,0 cm, 4"

spitz  
 sharp  
 agudo  
 pointu  
 acuto

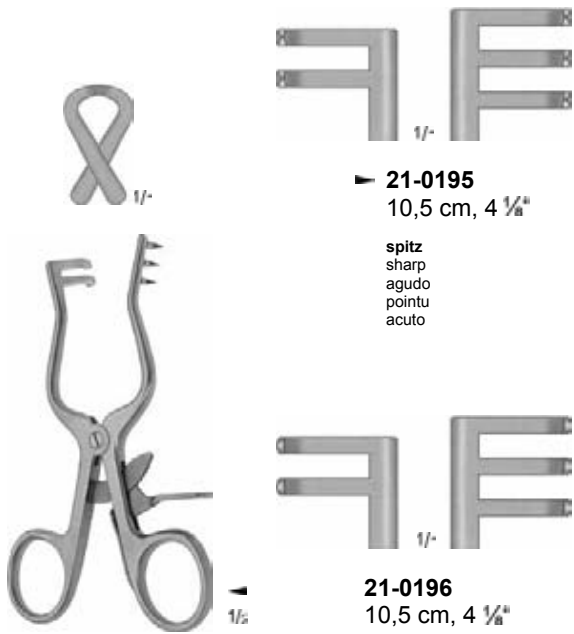

**WEITLANER**  
**21-0195**  
 - 21-0196

▶ **21-0195**  
 10,5 cm, 4 1/8"

spitz  
 sharp  
 agudo  
 pointu  
 acuto

▶ **21-0196**  
 10,5 cm, 4 1/8"

stumpf  
 blunt  
 romo  
 mousse  
 smusso



**WEITLANER**  
**21-0200**  
 - 21-0220

▶ **21-0200**  
 13,5 cm, 5 1/8"

spitz  
 sharp  
 agudo  
 pointu  
 acuto

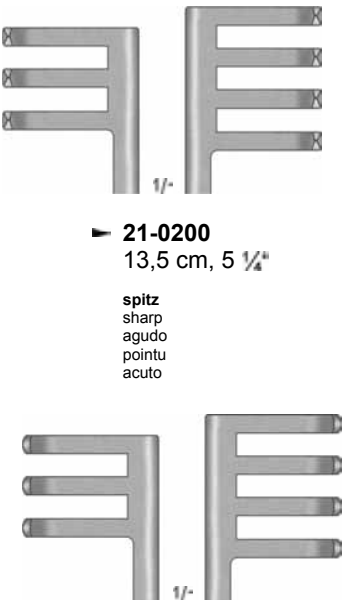

▶ **21-0220**  
 13,5 cm, 5 1/8"

stumpf  
 blunt  
 romo  
 mousse  
 smusso

▶ Photo shows this instrument.

**Wundspreizer, selbsthaltend**

Self-Retaining Retractors  
 Separadores autostáticos  
 Ecarteurs autostatiques  
 Divaricatori autostatici



► **21-0226**  
 13,0 cm, 5 1/4"

**spitz**  
 sharp  
 agudo  
 pointu  
 acuto



► **21-0205**  
 16,5 cm, 6 1/2"

**spitz**  
 sharp  
 agudo  
 pointu  
 acuto



► **21-0210**  
 19,5 cm, 7 3/4"

**spitz**  
 sharp  
 agudo  
 pointu  
 acuto



**21-0227**  
 13,0 cm, 5 1/4"

**stumpf**  
 blunt  
 romo  
 mousse  
 smusso



**21-0225**  
 16,5 cm, 6 1/2"

**stumpf**  
 blunt  
 romo  
 mousse  
 smusso



**21-0230**  
 19,5 cm, 7 3/4"

**stumpf**  
 blunt  
 romo  
 mousse  
 smusso



**WEITLANER**  
 21-0226  
 - 21-0227



**WEITLANER**  
 21-0205  
 - 21-0225



**WEITLANER**  
 21-0210  
 - 21-0230



**Wundspreizer, selbsthaltend**

Self-Retaining Retractors  
Separadores autostáticos  
Ecarteurs autostatiques  
Divaricatori autostatici



► **21-0215**  
25,0 cm, 10"

spitz  
sharp  
agudo  
pointu  
acuto

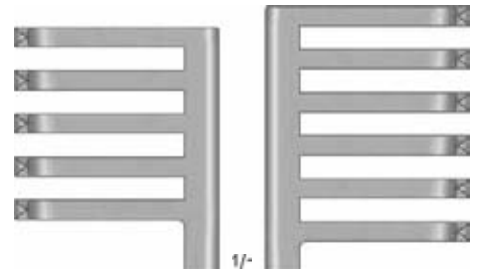

► **21-0216**  
25,5 cm, 10"

spitz  
sharp  
agudo  
pointu  
acuto

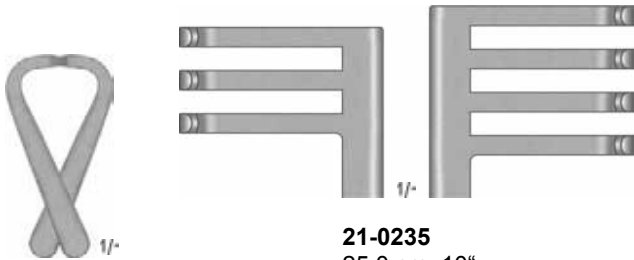

**21-0235**  
25,0 cm, 10"

stumpf  
blunt  
romo  
mousse  
smusso

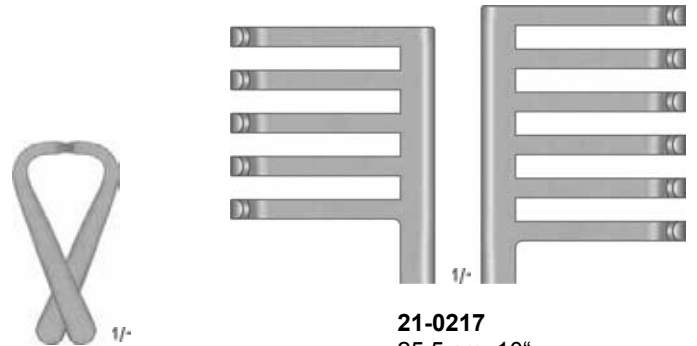

**21-0217**  
25,5 cm, 10"

stumpf  
blunt  
romo  
mousse  
smusso



WEITLANER  
21-0215  
1/2 - 21-0235



WEITLANER  
21-0216  
1/2 - 21-0217

7\ Uj YX'k N 'N Y'89AC'J9FG=CB'cZ758!?'5G'D8: !9Xlcf'fl hd.#kkk 'WX Ug'Wca L'  
H l'g'hl hcb'mUddYUg'p'N YXYa e'j Yfglcb" H l'g'hl hcb'mUddYUg'p'N YXYa e'j YX'k N 'N YZ "j Yfglcb"  
7\ Uj YX'k N 'N Y'89AC'J9FG=CB'cZ758!?'5G'D8: !9Xlcf'fl hd.#kkk 'WX Ug'Wca L'  
H l'g'hl hcb'mUddYUg'p'N YXYa e'j Yfglcb" H l'g'hl hcb'mUddYUg'p'N YXYa e'j YX'k N 'N YZ "j Yfglcb"  
7\ Uj YX'k N 'N Y'89AC'J9FG=CB'cZ758!?'5G'D8: !9Xlcf'fl hd.#kkk 'WX Ug'Wca L'

► Photo shows this instrument.

**Wundspreizer, selbsthaltend**

Self-Retaining Retractors  
Separadores autostáticos  
Ecarteurs autostatiques  
Divaricatori autostatici



**52-0420**

50 x 20 mm

Valve links voll  
Blade left full  
Valva a la izquierda plena  
Valve sur le bras à gauche  
Valva sul braccio sinistro



**52-0421**

50 x 20 mm

Valve rechts voll  
Blade right full  
Valva a la derecha plena  
Valve sur le bras à droite  
Valva sul braccio destro



**52-0422**

60 x 20 mm

Valve links voll  
Blade left full  
Valva a la izquierda plena  
Valve sur le bras à gauche  
Valva sul braccio sinistro



**52-0423**

60 x 20 mm

Valve rechts voll  
Blade right full  
Valva a la derecha plena  
Valve sur le bras à droite  
Valva sul braccio destro

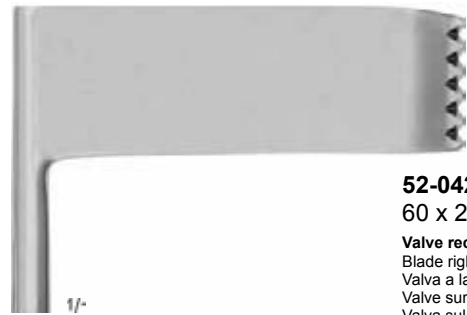

**52-0424**

70 x 20 mm

Valve links voll  
Blade left full  
Valva a la izquierda plena  
Valve sur le bras à gauche  
Valva sul braccio sinistro

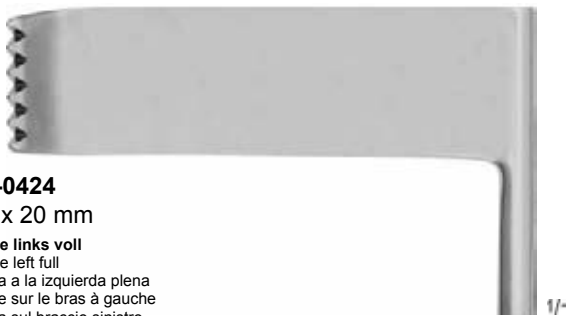

**52-0425**

70 x 20 mm

Valve rechts voll  
Blade right full  
Valva a la derecha plena  
Valve sur le bras à droite  
Valva sul braccio destro



WILLIAMS

52-0420

52-0425

17,0 cm, 6 3/4"

7\ Ubj YX'k N 'N Y'89AC'J9FG=CB'cZ7 58! ?5G'D8 : !9Xlcf' fl lnd.#k k k 'WX Ug'Wca r'  
H l'g'hl hcb mUddYUg' b'N Y'XYa e' j Yfglcb" H l'g'hl hcb mUddYUg' b'N Y'XYa e' j Yfglcb"  
7\ Ubj YX'k N 'N Y'89AC'J9FG=CB'cZ7 58! ?5G'D8 : !9Xlcf' fl lnd.#k k k 'WX Ug'Wca r'  
H l'g'hl hcb mUddYUg' b'N Y'XYa e' j Yfglcb" H l'g'hl hcb mUddYUg' b'N Y'XYa e' j Yfglcb"  
7\ Ubj YX'k N 'N Y'89AC'J9FG=CB'cZ7 58! ?5G'D8 : !9Xlcf' fl lnd.#k k k 'WX Ug'Wca r'  
H l'g'hl hcb mUddYUg' b'N Y'XYa e' j Yfglcb" H l'g'hl hcb mUddYUg' b'N Y'XYa e' j Yfglcb"



**Wundspreizer, selbsthaltend**

Self-Retaining Retractors  
 Separadores autostáticos  
 Ecarteurs autostatiques  
 Divaricatori autostatici



► **21-0280**  
 12,0 cm, 4 3/4"

spitz  
 sharp  
 agudo  
 pointu  
 acuto



► **21-0270**  
 13,0 cm, 5 1/8"

spitz  
 sharp  
 agudo  
 pointu  
 acuto

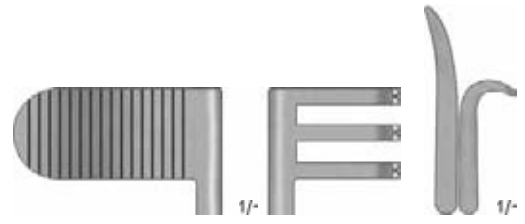

**21-0287**  
 13,0 cm, 5 1/8"

spitz, Valve links voll  
 sharp, blade left full  
 agudo, valva a la izquierda plena  
 pointu, valve bras à gauche  
 acuto, valva sul braccio sinistro



**21-0281**  
 12,0 cm, 4 3/4"

stumpf  
 blunt  
 romo  
 mousse  
 smusso



**21-0271**  
 13,0 cm, 5 1/8"

stumpf  
 blunt  
 romo  
 mousse  
 smusso

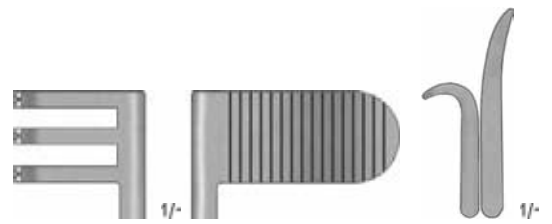

► **21-0286**  
 13,0 cm, 5 1/8"

spitz, Valve rechts voll  
 sharp, blade right full  
 agudo, valva a la derecha plena  
 pointu, valve bras à droite  
 acuto, valva sul braccio destro



**PLESTER**  
 21-0280  
 - 21-0281



**WULLSTEIN**  
 21-0270  
 - 21-0271



**PERKINS**  
 21-0286  
 - 21-0287

**Wundspreizer, selbsthaltend**

Self-Retaining Retractors  
 Separadores autostáticos  
 Ecarteurs autostatiques  
 Divaricatori autostatici

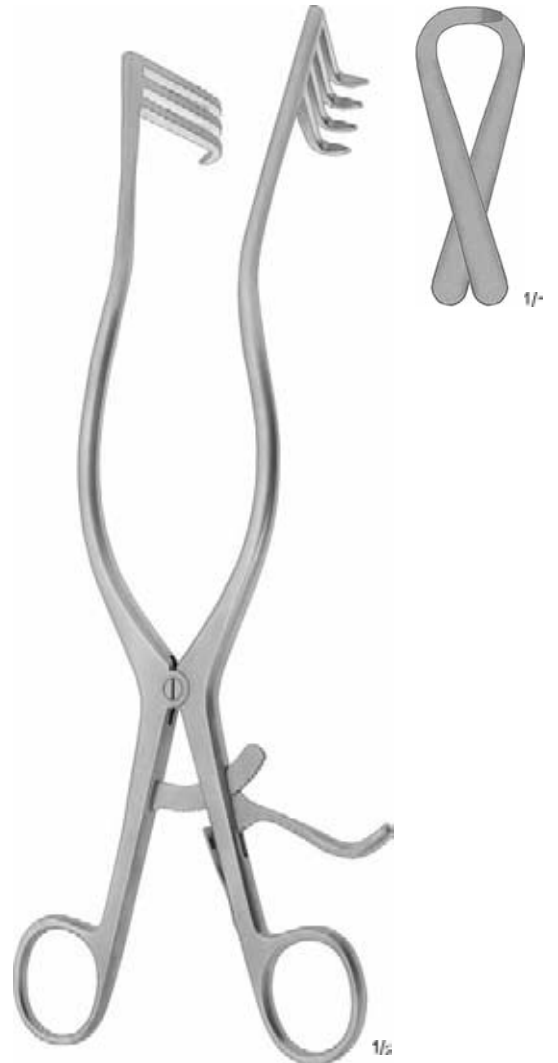
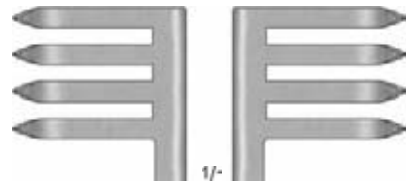
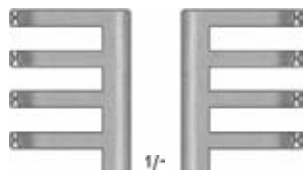

**MOLLISON**  
 21-0274  
 15,0 cm, 6"

spitz  
 sharp  
 agudo  
 pointu  
 acuto

**ANDERSON-ADSON**  
 21-0266  
 19,0 cm, 7 1/2"

spitz  
 sharp  
 agudo  
 pointu  
 acuto

**ADSON**  
 21-0261  
 28,0 cm, 11"

spitz  
 sharp  
 agudo  
 pointu  
 acuto





**Hemi-Laminektomie-Wundspreizer**

Hemi-Laminectomy Retractors

Separadores para hemilaminectomía

Ecarteurs pour hemilaminectomie

Divaricatori per emilaminectomia

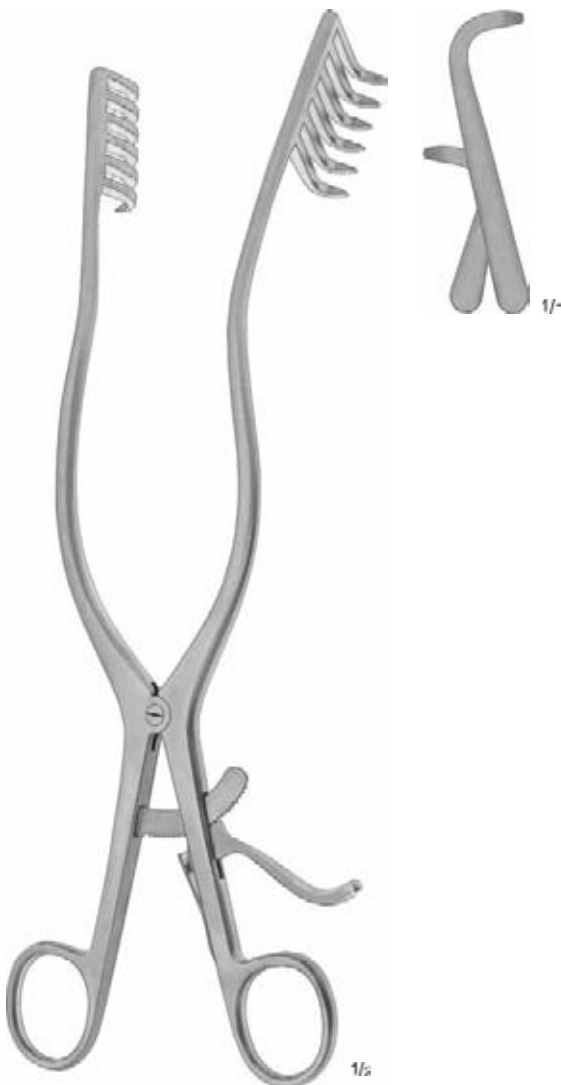
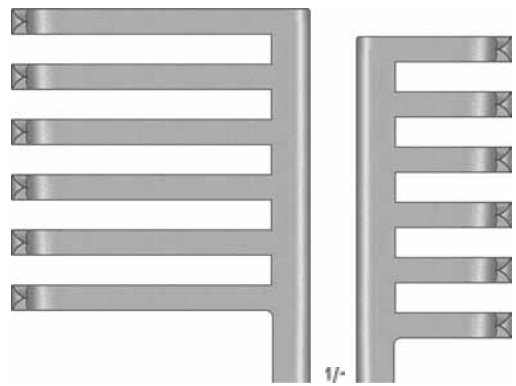
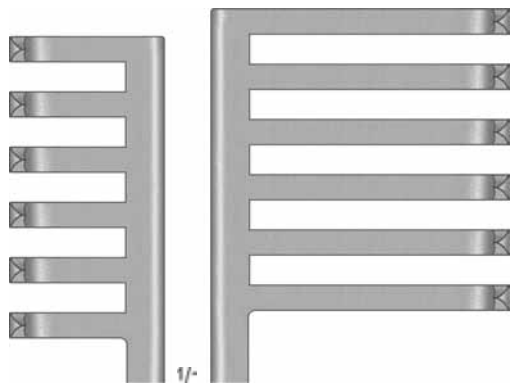

**ADSON**  
21-0267  
28,5 cm, 11 1/4"

spitz  
sharp  
agudo  
pointu  
acuto



**ADSON**  
21-0268  
28,5 cm, 11 1/4"

spitz  
sharp  
agudo  
pointu  
acuto

7\ Ubj YX'k N 'N Y'89AC'J9FG=CB'cZ7 58! ?5G'D8 : !9Xlcf' fl lnd.#k k k 'WX Ug'Wa r'  
H l g'hl hcb'mUddYUrg'lp'N YXYa e'j Yfglcb" H l g'hl hcb'mUddYUrg'lp'N YXYa e'j Yfglcb"  
7\ Ubj YX'k N 'N Y'89AC'J9FG=CB'cZ7 58! ?5G'D8 : !9Xlcf' fl lnd.#k k k 'WX Ug'Wa r'  
H l g'hl hcb'mUddYUrg'lp'N YXYa e'j Yfglcb" H l g'hl hcb'mUddYUrg'lp'N YXYa e'j Yfglcb"  
7\ Ubj YX'k N 'N Y'89AC'J9FG=CB'cZ7 58! ?5G'D8 : !9Xlcf' fl lnd.#k k k 'WX Ug'Wa r'  
H l g'hl hcb'mUddYUrg'lp'N YXYa e'j Yfglcb" H l g'hl hcb'mUddYUrg'lp'N YXYa e'j Yfglcb"

**Laminektomie-Wundspreizer**

Laminectomy Retractors

Separadores para laminectomía

Ecarteurs pour laminectomie

Divaricatori per laminectomia



**CONE**  
21-0258  
25,0 cm, 10"

spitz  
sharp  
agudo  
pointu  
acuto



**BECKMANN**  
12-0410  
31,5 cm, 12 1/2"

spitz  
sharp  
agudo  
pointu  
acuto



**Laminektomie-Wundspreizer**  
 Laminectomy Retractors  
 Separadores para laminectomía  
 Ecarteurs pour laminectomie  
 Divaricatori per laminectomia

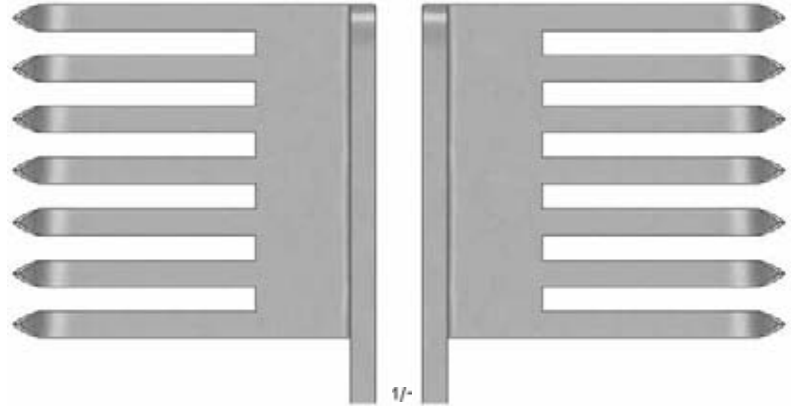
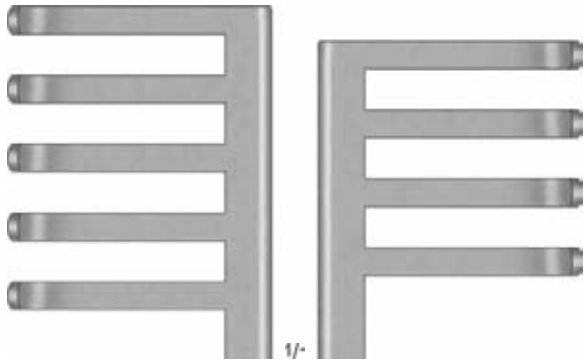

**ADSON**  
**52-0499**  
 33,0 cm, 13 1/4"  
 stump  
 blunt  
 romo  
 mousse  
 smusso



**BECKMANN-EATON**  
**21-0252**  
 32,0 cm, 12 3/4"  
 spitz  
 sharp  
 agudo  
 pointu  
 acuto

7\ Uj YXk N N Y89AC J9FG=CB cZ758! ?5G'D8 : !9Xlcf fl hd.#kkk 'WX Ug'Wa l'  
 H jgHl hcb mUddYUg b N YXYa e j Yfglcb" H jgHl hcb mUddYUg b N YXYa e j YX'k N N YZ " j Yfglcb"  
 7\ Uj YXk N N Y89AC J9FG=CB cZ758! ?5G'D8 : !9Xlcf fl hd.#kkk 'WX Ug'Wa l'  
 H jgHl hcb mUddYUg b N YXYa e j Yfglcb" H jgHl hcb mUddYUg b N YXYa e j YX'k N N YZ " j Yfglcb"  
 7\ Uj YXk N N Y89AC J9FG=CB cZ758! ?5G'D8 : !9Xlcf fl hd.#kkk 'WX Ug'Wa l'

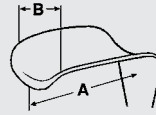

**SCOVILLE-RICHTER**  
**52-0430**

**Wundspreizer mit Kugelschnellverschluss, komplett, bestehend aus:**  
 52-0431 1 Rahmen  
 52-0432 1 Seitenvalve 63 x 37 mm  
 52-0433 1 Seitenvalve 63 x 52 mm

Self-retaining retractor with ball snap closure, complete, consisting of:  
 52-0431 1 spreader  
 52-0432 1 lateral valve 63 x 37 mm  
 52-0433 1 lateral valve 63 x 52 mm

Separador con cierre rápido esférico, completo, compuesto de:  
 52-0431 1 bastidor  
 52-0432 1 valva lateral 63 x 37 mm  
 52-0433 1 valva lateral 63 x 52 mm

Ecarteur avec fermeture à sphère, complet, composé de:  
 52-0431 1 cadre  
 52-0432 1 valve latérale 63 x 37 mm  
 52-0433 1 valve latérale 63 x 52 mm

Divaricatore a chiusura istantanea, completo, composto da:  
 52-0431 1 telaio  
 52-0432 1 valva laterale 63 x 37 mm  
 52-0433 1 valva laterale 63 x 52 mm



**52-0432**  
 63 x 37 mm (AxB)



**52-0433**  
 63 x 52 mm (AxB)



**52-0434**  
 49 x 51 mm (AxB)



**52-0435**  
 30 x 40 mm (AxB)



**52-0436**  
 37 x 62 mm (AxB)

**Seitenvalven mit Kugelschnellverschluss, für Wundspreizer 52-0430**  
 Lateral valves with ball snap closure, for self-retaining retractor 52-0430  
 Valvas laterales con cierre rápido esférico para separador 52-0430  
 Valves latérales avec fermeture à sphère, pour ecarteur 52-0430  
 Valve laterali a chiusura istantanea per divaricatore 52-0430



**Laminektomie-Wundspreizer**  
 Laminectomy Retractors  
 Separadores para laminectomía  
 Ecarteurs pour laminectomie  
 Divaricatori per laminectomia



**MAYO-ADAMS**  
**21-0320**  
 17,0 cm, 6 3/4"

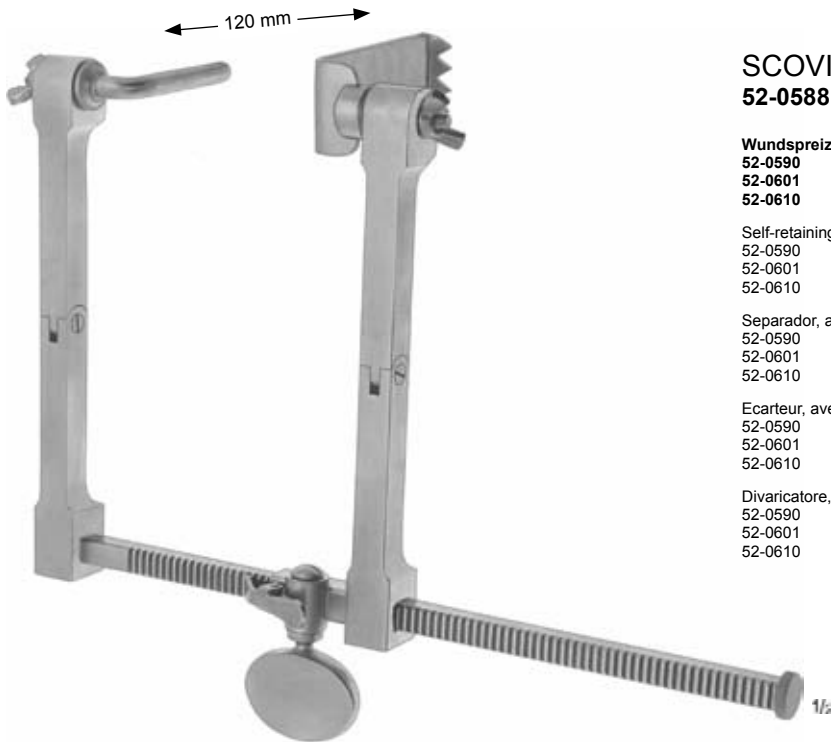
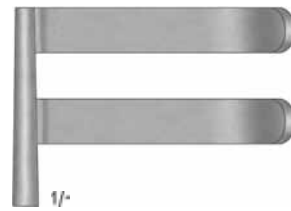
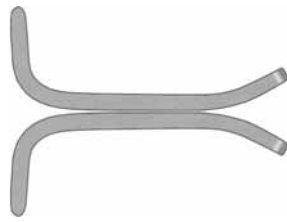

**SCOVILLE-HAVERFIELD**  
**52-0588**

Wundspreizer, mit Gelenkarmen, komplett, bestehend aus:  
 52-0590 1 Rahmen,  
 52-0601 1 Haken 75 mm  
 52-0610 1 Seitenvulve 63 x 25 mm

Self-retaining retractor, with articulated arms, complete, consisting of:  
 52-0590 1 frame  
 52-0601 1 hook 75 mm  
 52-0610 1 lateral valve 63 x 25 mm

Separador, autostático con brazos articulados, completo, compuesto de:  
 52-0590 1 bastidor  
 52-0601 1 gancho 75 mm  
 52-0610 1 valva lateral 63 x 25 mm

Ecarteur, avec bras articulés, complet, composé de:  
 52-0590 1 cadre  
 52-0601 1 crochet 75 mm  
 52-0610 1 valve latérale 63 x 25 mm

Divaricatore, con braccio articolato, completo, composto da:  
 52-0590 1 telaio  
 52-0601 1 uncino 75 mm  
 52-0610 1 valva laterale 63 x 25 mm

7\ Ubj YX'k N 'N Y'89AC'J9FG=CB'cZ7 58! ?5G'D8 : !9Xlcf' fl hd.#k k k 'WDX Ug'Wca r'  
 H l g'hl hsb mUddYUg' b'N YXYa e' j Yfglcb" H l g'hl hwb' VYfYa e j YX'k N 'N YZ " j Yfglcb"  
 7\ Ubj YX'k N 'N Y'89AC'J9FG=CB'cZ7 58! ?5G'D8 : !9Xlcf' fl hd.#k k k 'WDX Ug'Wca r'  
 H l g'hl hcb mUddYUg' b'N YXYa e' j Yfglcb" H l g'hl hwb' VYfYa e j YX'k N 'N YZ " j Yfglcb"  
 7\ Ubj YX'k N 'N Y'89AC'J9FG=CB'cZ7 58! ?5G'D8 : !9Xlcf' fl hd.#k k k 'WDX Ug'Wca r'

**Haken**  
Hooks  
Ganchos  
Crochets  
Uncini

**Seitenvalven**  
Lateral Valves  
Valvas laterales  
Valves latérales  
Valve laterali

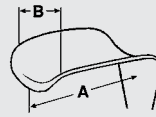

**SCOVILLE**

- ▶ **52-0600** 50 mm
- 52-0601** 75 mm

**Haken für Wundspreizer 52-0588**  
Hooks for self-retaining retractor 52-0588  
Ganchos para separador 52-0588  
Crochets pour écarteur 52-0588  
Uncini per divaricatore 52-0588



**SCOVILLE**

- 52-0610** 63 x 25 mm (AxB)
- 52-0611** 63 x 50 mm (AxB)
- ▶ **52-0613** 88 x 25 mm (AxB)

**Seitenvalven für Wundspreizer 52-0588**  
Lateral valves for self-retaining retractor 52-0588  
Valvas laterales para separador 52-0588  
Valves latérales pour écarteur 52-0588  
Valve laterali per divaricatore 52-0588



**SCOVILLE**

- ▶ **52-0620** 41 x 38 mm (AxB)
- 52-0621** 67 x 44 mm (AxB)

**Seitenvalven für Wundspreizer 52-0588**  
Lateral valves for self-retaining retractor 52-0588  
Valvas laterales para separador 52-0588  
Valves latérales pour écarteur 52-0588  
Valve laterali per divaricatore 52-0588



**TAYLOR**

- 52-0685** 48 x 50 mm (AxB)
- ▶ **52-0686** 64 x 63 mm (AxB)
- 52-0687** 80 x 57 mm (AxB)

**Seitenvalven für Wundspreizer 52-0588**  
Lateral valves for self-retaining retractor 52-0588  
Valvas laterales para separador 52-0588  
Valves latérales pour écarteur 52-0588  
Valve laterali per divaricatore 52-0588

7\ Ubj YX'k N 'N Y'89AC'J9FG=CB'cZ7 58! ?5G'D8 : !9Xlcf' fl hd.#k k k 'WX Ug'Wa r'  
H l'hl hsb mUddYUg'p'N Y'XYa e'j Yfglcb" H l'hl hWUb'VYfYa c'j YX'k N 'N Y'Z "j Yfglcb"  
7\ Ubj YX'k N 'N Y'89AC'J9FG=CB'cZ7 58! ?5G'D8 : !9Xlcf' fl hd.#k k k 'WX Ug'Wa r'  
H l'hl hsb mUddYUg'p'N Y'XYa c'j Yfglcb" H l'hl hWUb'VYfYa c'j YX'k N 'N Y'Z "j Yfglcb"  
7\ Ubj YX'k N 'N Y'89AC'J9FG=CB'cZ7 58! ?5G'D8 : !9Xlcf' fl hd.#k k k 'WX Ug'Wa r'



**Wundspreizer für die Wirbelsäule**  
 Retractors for vertebral column  
 Separadores para la columna vertebral  
 Ecarteurs pour colonne vertébrale  
 Divaricatori per colonna vertebrale

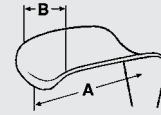

**Lumbal, thorakal und cervical einzusetzen!**  
 For use of lumbar, thoracic and cervical!  
 Utilizable en el área lumbar, toracal y cervical!  
 Pour utiliser dans la région lombaire, thoracique et cervicale  
 Per l'utilizzo nella regione lombare, toracica e cervicale

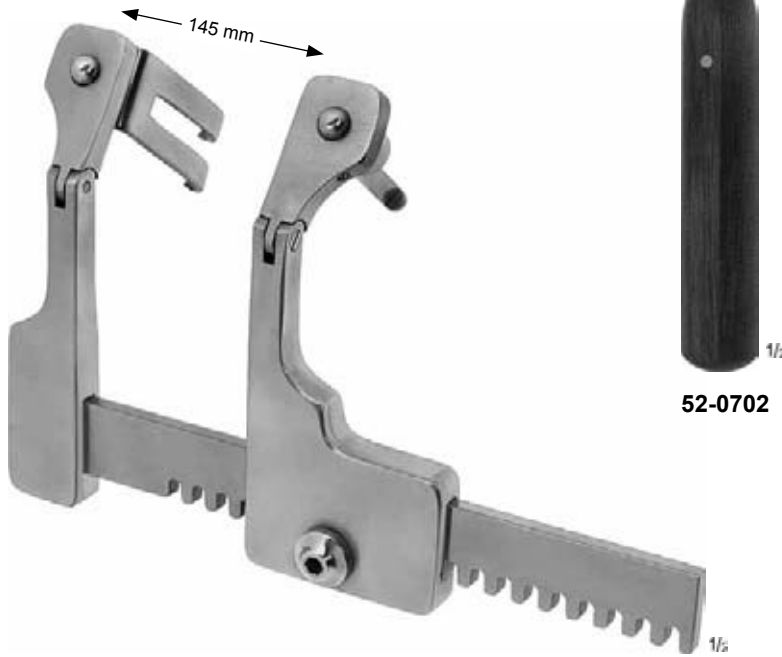

**52-0705**  
38 mm



**52-0711**  
37 x 22 mm (AxB)



**52-0712**  
43 x 22 mm (AxB)



**52-0713**  
47 x 22 mm (AxB)



**52-0714**  
52 x 22 mm (AxB)



**52-0715**  
57 x 22 mm (AxB)

**CASPAR**  
**52-0700**

Wundspreizer mit Gelenkarmen und Kugelschnellverschluss, für Laminektomie und Hemi-Laminektomie, komplett, bestehend aus:

- 52-0701 1 Rahmen
- 52-0702 1 Drehschlüssel
- 52-0705 1 Haken 38 mm
- 52-0711 1 Seitenvulve 37 x 22 mm
- 52-0712 1 Seitenvulve 43 x 22 mm
- 52-0713 1 Seitenvulve 47 x 22 mm
- 52-0714 1 Seitenvulve 52 x 22 mm
- 52-0715 1 Seitenvulve 57 x 22 mm

Self-retaining retractor with articulated arms and ball snap closure, for laminectomy and hemi-laminectomy, complete, consisting of:

- 52-0701 1 frame
- 52-0702 1 key
- 52-0705 1 hook 38 mm
- 52-0711 1 lateral valve 37 x 22 mm
- 52-0712 1 lateral valve 43 x 22 mm
- 52-0713 1 lateral valve 47 x 22 mm
- 52-0714 1 lateral valve 52 x 22 mm
- 52-0715 1 lateral valve 57 x 22 mm

Separador con brazos articulados y cierre rápido esférico, para laminectomía y hemilaminectomía, completo, compuesto de:

- 52-0701 1 bastidor
- 52-0702 1 llave
- 52-0705 1 gancho 38 mm
- 52-0711 1 valva lateral 37 x 22 mm
- 52-0712 1 valva lateral 43 x 22 mm
- 52-0713 1 valva lateral 47 x 22 mm
- 52-0714 1 valva lateral 52 x 22 mm
- 52-0715 1 valva lateral 57 x 22 mm

Ecarteur pour laminectomie et hémi laminectomie avec bras articulés, fermeture à sphère, complet, composé de:

- 52-0701 1 cadre
- 52-0702 1 clé
- 52-0705 1 crochet 38 mm
- 52-0711 1 valve latérale 37 x 22 mm
- 52-0712 1 valve latérale 43 x 22 mm
- 52-0713 1 valve latérale 47 x 22 mm
- 52-0714 1 valve latérale 52 x 22 mm
- 52-0715 1 valve latérale 57 x 22 mm

Divaricatore per laminectomia ed emilaminectomia con braccio articolato a chiusura istantanea, completo, composto da:

- 52-0701 1 telaio
- 52-0702 1 chiave
- 52-0705 1 uncino 38 mm
- 52-0711 1 valva laterale 37 x 22 mm
- 52-0712 1 valva laterale 43 x 22 mm
- 52-0713 1 valva laterale 47 x 22 mm
- 52-0714 1 valva laterale 52 x 22 mm
- 52-0715 1 valva laterale 57 x 22 mm

7\ Ubj YX'k N 'N Y'89AC'J9FG=CB'cZ7 58! ?5G'D8 : !9Xlcf' fl Hd.#k k k 'WX Ug'Wa l'  
 H l'g'hl hcb'mUddYUg'p'N Y'XYa e'j Yfglcb" H l'g'hl hWb'VYfYa e j YX'k N 'N Y'Z "j Yfglcb"  
 7\ Ubj YX'k N 'N Y'89AC'J9FG=CB'cZ7 58! ?5G'D8 : !9Xlcf' fl Hd.#k k k 'WX Ug'Wa l'  
 H l'g'hl hcb'mUddYUg'p'N Y'XYa e'j Yfglcb" H l'g'hl hWb'VYfYa e j YX'k N 'N Y'Z "j Yfglcb"  
 7\ Ubj YX'k N 'N Y'89AC'J9FG=CB'cZ7 58! ?5G'D8 : !9Xlcf' fl Hd.#k k k 'WX Ug'Wa l'

**Haken**  
Hooks  
Ganchos  
Crochets  
Uncini

**Seitenvalven**  
Lateral Valves  
Valvas laterales  
Valves latérales  
Valve laterali

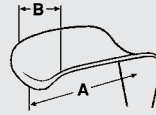

- 52-0705 38 mm
- 52-0706 58 mm

**Haken mit Kugelschnellverschluss, für Wundspreizer 52-0700**

Hooks with ball snap closure, for self-retaining retractor 52-0700

Ganchos con cierre rápido esférico para separador 52-0700

Crochets avec fermeture à sphère pour écarteur 52-0700

Uncini a chiusura istantanea per divaricatore 52-0700



- 52-0710 32 x 22 mm (AxB)
- 52-0711 37 x 22 mm (AxB)
- 52-0712 43 x 22 mm (AxB)
- 52-0713 47 x 22 mm (AxB)
- 52-0714 52 x 22 mm (AxB)
- 52-0715 57 x 22 mm (AxB)
- 52-0716 62 x 22 mm (AxB)
- 52-0717 67 x 22 mm (AxB)

**Seitenvalven mit Kugelschnellverschluss, für Wundspreizer 52-0700**

Lateral valves with ball snap closure, for self-retaining retractor 52-0700

Valvas laterales con cierre rápido esférico, para separador 52-0700

Valves latérales avec fermeture à sphère, pour écarteur 52-0700

Valve laterali a chiusura istantanea per divaricatore 52-0700



- 52-0720 32 x 37 mm (AxB)
- 52-0721 37 x 37 mm (AxB)
- 52-0722 43 x 37 mm (AxB)
- 52-0723 47 x 37 mm (AxB)
- 52-0724 52 x 37 mm (AxB)
- 52-0725 57 x 37 mm (AxB)
- 52-0726 62 x 37 mm (AxB)
- 52-0727 67 x 37 mm (AxB)

**Seitenvalven mit Kugelschnellverschluss, für Wundspreizer 52-0700**

Lateral valves with ball snap closure, for self-retaining retractor 52-0700

Valvas laterales con cierre rápido esférico, para separador 52-0700

Valves latérales avec fermeture à sphère, pour écarteur 52-0700

Valve laterali a chiusura istantanea per divaricatore 52-0700



- 52-0730 32 x 52 mm (AxB)
- 52-0731 37 x 52 mm (AxB)
- 52-0732 43 x 52 mm (AxB)
- 52-0733 47 x 52 mm (AxB)
- 52-0734 52 x 52 mm (AxB)
- 52-0735 57 x 52 mm (AxB)
- 52-0736 62 x 52 mm (AxB)
- 52-0737 67 x 52 mm (AxB)

**Seitenvalven mit Kugelschnellverschluss, für Wundspreizer 52-0700**

Lateral valves with ball snap closure, for self-retaining retractor 52-0700

Valvas laterales con cierre rápido esférico, para separador 52-0700

Valves latérales avec fermeture à sphère, pour écarteur 52-0700

Valve laterali a chiusura istantanea per divaricatore 52-0700



- 52-0739  
11,5 cm, 4 1/2"

**Pinzette zum Valvenwechsel bei Kugelschnellverschluss-System**

Valve ejector for changing the valves with ball snap closure system

Pinza para el cambio de las valvas del sistema de cierre rápido esférico

Pince pour changer les valves avec système à sphère

Pinza per il cambio delle valve a chiusura istantanea





**Wundspreizer für die cervicale Wirbelsäule**

Retractors for cervical vertebral column  
 Separadores para la columna cervical  
 Ecarteurs pour colonne cervicale  
 Divaricatori per colonna cervicale

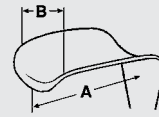

**In Wirbelsäulen-Längsachse zu verwenden!**  
 To be used for up and down retraction!  
 Útilizable en el eje longitudinal de la columna vertebral!  
 Utilisé du haut en bas de la colonne vertébrale  
 Per trazione/compressione della colonna vertebrale



**52-0780**  
 45 x 23 mm (AxB)



**52-0781**  
 50 x 23 mm (AxB)



**52-0782**  
 55 x 23 mm (AxB)



**52-0783**  
 60 x 23 mm (AxB)



**52-0784**  
 65 x 23 mm (AxB)

**CASPAR**

**52-0740**  
 16,5 cm, 6 1/2"

Wundspreizer mit Gelenkarmen und Kugelschnellverschluss, komplett, bestehend aus:

- 52-0742 1 Sperrer
- 52-0780 1 stumpfen Valve 45 x 23 mm
- 52-0781 1 stumpfen Valve 50 x 23 mm
- 52-0782 1 stumpfen Valve 55 x 23 mm
- 52-0783 1 stumpfen Valve 60 x 23 mm
- 52-0784 1 stumpfen Valve 65 x 23 mm

Self-retaining retractor with articulated arms and ball snap closure, complete, consisting of:

- 52-0742 1 spreader
- 52-0780 1 blunt valve 45 x 23 mm
- 52-0781 1 blunt valve 50 x 23 mm
- 52-0782 1 blunt valve 55 x 23 mm
- 52-0783 1 blunt valve 60 x 23 mm
- 52-0784 1 blunt valve 65 x 23 mm

Separador con brazos articulados y cierre rápido esférico, completo, compuesto de:

- 52-0742 1 separador
- 52-0780 1 valva roma 45 x 23 mm
- 52-0781 1 valva roma 50 x 23 mm
- 52-0782 1 valva roma 55 x 23 mm
- 52-0783 1 valva roma 60 x 23 mm
- 52-0784 1 valva roma 65 x 23 mm

Ecarteur avec bras articulés, fermeture à sphère, complet, composé de:

- 52-0742 1 ecarteur
- 52-0780 1 valve mousse 45 x 23 mm
- 52-0781 1 valve mousse 50 x 23 mm
- 52-0782 1 valve mousse 55 x 23 mm
- 52-0783 1 valve mousse 60 x 23 mm
- 52-0784 1 valve mousse 65 x 23 mm

Divaricatore con braccio articolato a chiusura istantanea, completo, composto da:

- 52-0742 1 divaricatore
- 52-0780 1 valva smussa 45 x 23 mm
- 52-0781 1 valva smussa 50 x 23 mm
- 52-0782 1 valva smussa 55 x 23 mm
- 52-0783 1 valva smussa 60 x 23 mm
- 52-0784 1 valva smussa 65 x 23 mm

7\ Ubj YX'k N 'N Y'89AC'J9FG=CB'cZ7 58! ?5G'D8 : !9Xlcf' fl hd.#k k k 'WX Ug'Wa l'  
 H l'g'hl hsb'mUddYUg'p'N Y'XYa e'j Yfglcb" H l'g'hl hWb'VY'fYa e'j YX'k N 'N Y'Z "j Yfglcb"  
 7\ Ubj YX'k N 'N Y'89AC'J9FG=CB'cZ7 58! ?5G'D8 : !9Xlcf' fl hd.#k k k 'WX Ug'Wa l'  
 H l'g'hl hcb'mUddYUg'p'N Y'XYa c'j Yfglcb" H l'g'hl hWb'VY'fYa c'j YX'k N 'N Y'Z "j Yfglcb"  
 7\ Ubj YX'k N 'N Y'89AC'J9FG=CB'cZ7 58! ?5G'D8 : !9Xlcf' fl hd.#k k k 'WX Ug'Wa l'

**Wundspreizer für die cervicale Wirbelsäule**

Retractors for cervical vertebral column  
 Separadores para la columna cervical  
 Ecarteurs pour colonne cervicale  
 Divaricatori per colonna cervicale

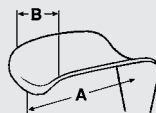

**In Wirbelsäulen-Längsachse zu verwenden!**  
 To be used for up and down retraction!  
 Utilizable en el eje longitudinal de la columna vertebral!  
 Utilisé du haut en bas de la colonne vertébrale  
 Per trazione/compressione della colonna vertebrale



**CASPAR**

**52-0745**

10,5 cm, 4 1/4"

Wundspreizer mit Gelenkarmen und Kugelschnellverschluss, komplett, bestehend aus:

- 52-0746 1 Sperrer
- 52-0780 1 stumpfen Valve 45 x 23 mm
- 52-0781 1 stumpfen Valve 50 x 23 mm
- 52-0782 1 stumpfen Valve 55 x 23 mm
- 52-0783 1 stumpfen Valve 60 x 23 mm
- 52-0784 1 stumpfen Valve 65 x 23 mm

Self-retaining retractor with articulated arms and ball snap closure, complete, consisting of:

- 52-0746 1 spreader
- 52-0780 1 blunt valve 45 x 23 mm
- 52-0781 1 blunt valve 50 x 23 mm
- 52-0782 1 blunt valve 55 x 23 mm
- 52-0783 1 blunt valve 60 x 23 mm
- 52-0784 1 blunt valve 65 x 23 mm

Separador con brazos articulados y cierre rápido esférico, completo, compuesto de:

- 52-0746 1 separador
- 52-0780 1 valva roma 45 x 23 mm
- 52-0781 1 valva roma 50 x 23 mm
- 52-0782 1 valva roma 55 x 23 mm
- 52-0783 1 valva roma 60 x 23 mm
- 52-0784 1 valva roma 65 x 23 mm

Ecarteur avec bras articulés, fermeture à sphère, complet composé de:

- 52-0746 1 ecarteur
- 52-0780 1 valve mousse 45 x 23 mm
- 52-0781 1 valve mousse 50 x 23 mm
- 52-0782 1 valve mousse 55 x 23 mm
- 52-0783 1 valve mousse 60 x 23 mm
- 52-0784 1 valve mousse 65 x 23 mm

Divaricatore con braccio articolato a chiusura istantanea, completo, composto da:

- 52-0746 1 divaricatore
- 52-0780 1 valva smussa 45 x 23 mm
- 52-0781 1 valva smussa 50 x 23 mm
- 52-0782 1 valva smussa 55 x 23 mm
- 52-0783 1 valva smussa 60 x 23 mm
- 52-0784 1 valva smussa 65 x 23 mm



**52-0780**  
45 x 23 mm (AxB)



**52-0781**  
50 x 23 mm (AxB)



**52-0782**  
55 x 23 mm (AxB)



**52-0783**  
60 x 23 mm (AxB)



**52-0784**  
65 x 23 mm (AxB)

7\ Ubj YX'k N 'N Y'89AC'J9FG=CB'cZ7 58! ?5G'D8 : !9Xlcf' fl Hd.#k k k 'WX Ug'Wa r'  
 H l'g'hl hcb'mUddYUrg'p'N Y'XYa e'j Yfglcb" H l'g'hl hWUb'VY'fYa c'j YX'k N 'N Y'Z "j Yfglcb"  
 7\ Ubj YX'k N 'N Y'89AC'J9FG=CB'cZ7 58! ?5G'D8 : !9Xlcf' fl Hd.#k k k 'WX Ug'Wa r'  
 H l'g'hl hcb'mUddYUrg'p'N Y'XYa c'j Yfglcb" H l'g'hl hWUb'VY'fYa c'j YX'k N 'N Y'Z "j Yfglcb"  
 7\ Ubj YX'k N 'N Y'89AC'J9FG=CB'cZ7 58! ?5G'D8 : !9Xlcf' fl Hd.#k k k 'WX Ug'Wa r'



**Wundspreizer für die cervicale Wirbelsäule**

Retractors for cervical vertebral column  
 Separadores para la columna cervical  
 Ecarteurs pour colonne cervicale  
 Divaricatori per colonna cervicale

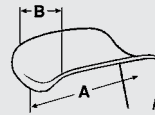

**Transversal zu verwenden!**  
 To be used to transverse retraction!  
 Utilizable para retracción transversal!  
 Utilisé pour retraction transversale  
 Per trazioni trasversali



**52-0770**  
 40 x 23 mm (AxB)



**52-0775**  
 40 x 23 mm (AxB)



**52-0771**  
 45 x 23 mm (AxB)



**52-0776**  
 45 x 23 mm (AxB)



**52-0772**  
 50 x 23 mm (AxB)



**52-0777**  
 50 x 23 mm (AxB)



**52-0773**  
 55 x 23 mm (AxB)



**52-0778**  
 55 x 23 mm (AxB)



**52-0774**  
 60 x 23 mm (AxB)



**52-0779**  
 60 x 23 mm (AxB)

**CASPAR**  
**52-0750**

Wundspreizer mit Gelenkarmen und Kugelschnellverschluss, komplett, bestehend aus:

- 52-0751 1 Rahmen
- 52-0770 1 medialen Valve 40 x 23 mm
- 52-0771 1 medialen Valve 45 x 23 mm
- 52-0772 1 medialen Valve 50 x 23 mm
- 52-0773 1 medialen Valve 55 x 23 mm
- 52-0774 1 medialen Valve 60 x 23 mm
- 52-0775 1 lateralen Valve 40 x 23 mm
- 52-0776 1 lateralen Valve 45 x 23 mm
- 52-0777 1 lateralen Valve 50 x 23 mm
- 52-0778 1 lateralen Valve 55 x 23 mm
- 52-0779 1 lateralen Valve 60 x 23 mm

Self-retaining retractor with articulated arms and ball snap closure, complete, consisting of:

- 52-0751 1 frame
- 52-0770 1 medial valve 40 x 23 mm
- 52-0771 1 medial valve 45 x 23 mm
- 52-0772 1 medial valve 50 x 23 mm
- 52-0773 1 medial valve 55 x 23 mm
- 52-0774 1 medial valve 60 x 23 mm
- 52-0775 1 lateral valve 40 x 23 mm
- 52-0776 1 lateral valve 45 x 23 mm
- 52-0777 1 lateral valve 50 x 23 mm
- 52-0778 1 lateral valve 55 x 23 mm
- 52-0779 1 lateral valve 60 x 23 mm

Separador con brazos articulados y cierre rápido esférico, completo, compuesto de:

- 52-0751 1 bastidor
- 52-0770 1 valva mediana 40 x 23 mm
- 52-0771 1 valva mediana 45 x 23 mm
- 52-0772 1 valva mediana 50 x 23 mm
- 52-0773 1 valva mediana 55 x 23 mm
- 52-0774 1 valva mediana 60 x 23 mm
- 52-0775 1 valva lateral 40 x 23 mm
- 52-0776 1 valva lateral 45 x 23 mm
- 52-0777 1 valva lateral 50 x 23 mm
- 52-0778 1 valva lateral 55 x 23 mm
- 52-0779 1 valva lateral 60 x 23 mm

Ecarteur avec bras articulés, fermeteure à sphère, complet composé de:

- 52-0751 1 cadre
- 52-0770 1 valve centrale 40 x 23 mm
- 52-0771 1 valve centrale 45 x 23 mm
- 52-0772 1 valve centrale 50 x 23 mm
- 52-0773 1 valve centrale 55 x 23 mm
- 52-0774 1 valve centrale 60 x 23 mm
- 52-0775 1 valve latérale 40 x 23 mm
- 52-0776 1 valve latérale 45 x 23 mm
- 52-0777 1 valve latérale 50 x 23 mm
- 52-0778 1 valve latérale 55 x 23 mm
- 52-0779 1 valve latérale 60 x 23 mm

Divaricatore con braccio articolato a chiusura istantanea, completo, composto da:

- 52-0751 1 telaio
- 52-0770 1 valva centrale 40 x 23 mm
- 52-0771 1 valva centrale 45 x 23 mm
- 52-0772 1 valva centrale 50 x 23 mm
- 52-0773 1 valva centrale 55 x 23 mm
- 52-0774 1 valva centrale 60 x 23 mm
- 52-0775 1 valva laterale 40 x 23 mm
- 52-0776 1 valva laterale 45 x 23 mm
- 52-0777 1 valva laterale 50 x 23 mm
- 52-0778 1 valva laterale 55 x 23 mm
- 52-0779 1 valva laterale 60 x 23 mm

7\ Ubj YX'k N 'N Y'89AC'J9FG=CB'cZ7 58! ?5G'D8 : !9Xlcf' fl Hd.#k k k 'WX Ug'Wa l'  
 H l g h l hsb m Udd YUg' b'N YXYa e' j Yfglcb" H l g h l h Wb' VYfYa c j YX'k N 'N YZ' " j Yfglcb"  
 7\ Ubj YX'k N 'N Y'89AC'J9FG=CB'cZ7 58! ?5G'D8 : !9Xlcf' fl Hd.#k k k 'WX Ug'Wa l'  
 H l g h l hcb m Udd YUg' b'N YXYa c' j Yfglcb" H l g h l h Wb' VYfYa c j YX'k N 'N YZ' " j Yfglcb"  
 7\ Ubj YX'k N 'N Y'89AC'J9FG=CB'cZ7 58! ?5G'D8 : !9Xlcf' fl Hd.#k k k 'WX Ug'Wa l'

**Valven**

Valves  
Valvas  
Valves  
Valves  
Valve

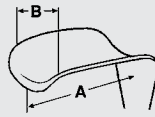

- ▶ **52-0770** 40 x 23 mm (AxB)
- 52-0771** 45 x 23 mm (AxB)
- 52-0772** 50 x 23 mm (AxB)
- 52-0773** 55 x 23 mm (AxB)
- 52-0774** 60 x 23 mm (AxB)

**Mediale Valven mit Kugelschnellverschluss, für Wundspreizer 52-0740 / 52-0745 / 52-0750**

Medial valves with ball snap closure, for self-retaining retractors 52-0740 / 52-0745 / 52-0750  
Valvas centrales con cierre rápido esférico, para separadores 52-0740 / 52-0745 / 52-0750  
Valves centrales avec fermeture à sphère, pour écarteurs 52-0740 / 52-0745 / 52-0750  
Valve centrali a chiusura istantanea per divaricatori 52-0740 / 52-0745 / 52-0750



- ▶ **52-0775** 40 x 23 mm (AxB)
- 52-0776** 45 x 23 mm (AxB)
- 52-0777** 50 x 23 mm (AxB)
- 52-0778** 55 x 23 mm (AxB)
- 52-0779** 60 x 23 mm (AxB)

**Laterale Valven mit Kugelschnellverschluss, für Wundspreizer 52-0740 / 52-0745 / 52-0750**

Lateral valves with ball snap closure, for self-retaining retractors 52-0740 / 52-0745 / 52-0750  
Valvas laterales con cierre rápido esférico, para separadores 52-0740 / 52-0745 / 52-0750  
Valves latérales avec fermeture à sphère, pour écarteurs 52-0740 / 52-0745 / 52-0750  
Valve laterali a chiusura istantanea per divaricatori 52-0740 / 52-0745 / 52-0750



- ▶ **52-0780** 45 x 23 mm (AxB)
- 52-0781** 50 x 23 mm (AxB)
- 52-0782** 55 x 23 mm (AxB)
- 52-0783** 60 x 23 mm (AxB)
- 52-0784** 65 x 23 mm (AxB)

**Stumpfe Valven mit Kugelschnellverschluss, für Wundspreizer 52-0740 / 52-0745 / 52-0750**

Blunt valves with ball snap closure, for self-retaining retractors 52-0740 / 52-0745 / 52-0750  
Valvas romas con cierre rápido esférico, para separadores 52-0740 / 52-0745 / 52-0750  
Valves mousses avec fermeture à sphère, pour écarteurs 52-0740 / 52-0745 / 52-0750  
Valve smusse a chiusura istantanea per divaricatori 52-0740 / 52-0745 / 52-0750



- ▶ **52-0785** 50 x 25 mm (AxB)
- 52-0786** 60 x 25 mm (AxB)

**Stumpfe Valven mit Kugelschnellverschluss zur Spanentnahme am Beckenkamm, für Wundspreizer 52-0740 / 52-0745 / 52-0750**

Blunt valves with ball snap closure, for harvesting of the fusion graft from the iliac crest, for self-retaining retractors 52-0740 / 52-0745 / 52-0750  
Valvas romas con cierre rápido esférico, para separadores 52-0740 / 52-0745 / 52-0750  
Valves mousses avec fermeture à sphère, pour écarteurs 52-0740 / 52-0745 / 52-0750  
Valve smusse a chiusura istantanea per divaricatori 52-0740 / 52-0745 / 52-0750



- ▶ **52-0790** 40 x 25 mm (AxB)
- 52-0791** 45 x 25 mm (AxB)
- 52-0792** 50 x 25 mm (AxB)
- 52-0793** 55 x 25 mm (AxB)
- 52-0794** 60 x 25 mm (AxB)

**Mediale Valven aus Titan, mit Kugelschnellverschluss, für Wundspreizer 52-0740 / 52-0745 / 52-0750**

Medial valves of Titanium, with ball snap closure, for self-retaining retractors 52-0740 / 52-0745 / 52-0750  
Valvas centrales de titanio, con cierre rápido esférico, para separadores 52-0740 / 52-0745 / 52-0750  
Valves centrales en titane avec fermeture à sphère, pour écarteurs 52-0740 / 52-0745 / 52-0750  
Valve centrali in titanio a chiusura istantanea per divaricatori 52-0740 / 52-0745 / 52-0750



- ▶ **52-0795** 40 x 25 mm (AxB)
- 52-0796** 45 x 25 mm (AxB)
- 52-0797** 50 x 25 mm (AxB)
- 52-0798** 55 x 25 mm (AxB)
- 52-0799** 60 x 25 mm (AxB)

**Laterale Valven aus Titan, mit Kugelschnellverschluss, für Wundspreizer 52-0740 / 52-0745 / 52-0750**

Lateral valves of Titanium, with ball snap closure, for self-retaining retractors 52-0740 / 52-0745 / 52-0750  
Valvas laterales de titanio, con cierre rápido esférico, para separadores 52-0740 / 52-0745 / 52-0750  
Valves latérales en titane avec fermeture à sphère, pour écarteurs 52-0740 / 52-0745 / 52-0750  
Valve laterali in titanio a chiusura istantanea per divaricatori 52-0740 / 52-0745 / 52-0750

7\ Ubj YX'k N 'N Y'89AC'J9FG=CB'cZ758!?'5G'D8: !9Xlcf'fl Hd.#k k k 'WX Ug'Wa r'  
H l'hl hcb mUddYUg'p'N YXYa e'j Yfglcb'H l'hl hWb'VYfYa c j YX'k N 'N YZ' "j Yfglcb"  
7\ Ubj YX'k N 'N Y'89AC'J9FG=CB'cZ758!?'5G'D8: !9Xlcf'fl Hd.#k k k 'WX Ug'Wa r'  
H l'hl hcb mUddYUg'p'N YXYa e'j Yfglcb'H l'hl hWb'VYfYa c j YX'k N 'N YZ' "j Yfglcb"  
7\ Ubj YX'k N 'N Y'89AC'J9FG=CB'cZ758!?'5G'D8: !9Xlcf'fl Hd.#k k k 'WX Ug'Wa r'



**Wundspreizer für die cervicale Wirbelsäule**

Retractors for cervical vertebral column  
 Separadores para la columna cervical  
 Ecarteurs pour colonne cervicale  
 Divaricatori per colonna cervicale

**52-1810**  
 16,5 cm, 6 1/2"



**52-1810-Ti**  
 16,5 cm, 6 1/2"

**Gegenspreizer, Basismodell, mit Gelenkarmen und Kugelschnellverschluss, für Valven 52-1830 - 52-1978**

Basic counter retractors, with articulated arms and ball snap closure, for valves 52-1830 - 52-1978

Contraseparador, modelo básico, con brazos articulados y cierre rápido esférico, para valvas 52-1830 - 52-1978

Ecarteur inverse, modèle de base avec bras mobile et fermeture à sphère pour valves 52-1830 - 52-1978

Divaricatore inverso, modello base con braccio mobile e chiusura istantanea per valve 52-1830 - 52-1978



**52-1812**  
 17,0 cm, 6 3/4"

**Gegenspreizer, Basismodell, mit Gelenkarmen aus Peek und Kugelschnellverschluss, für Valven 52-1830 - 52-1978**

Basic counter retractor, with articulated arms, made of Peek, and ball snap closure, for valves 52-1830 - 52-1978

Contraseparador, modelo básico, con brazos articulados de peek y cierre rápido esférico, para valvas 52-1830 - 52-1978

Ecarteur inverse, modèle de base avec bras mobile en peek et fermeture à sphère pour valves 52-1830 - 52-1978

Divaricatore inverso, modello base con braccio mobile in peek e chiusura istantanea per valve 52-1830 - 52-1978

**52-1800**

**52-1800-Ti**

**Cervicaler Sperrer, Basismodell, mit Gelenkarmen und Kugelschnellverschluss, für Valven 52-1830 - 52-1978**

Basic cervical retractors, with articulated arms and ball snap closure, for valves 52-1830 - 52-1978

Separador cervical, modelo básico, con brazos articulados y cierre rápido esférico, para valvas 52-1830 - 52-1978

Ecarteur pour colonne cervicale, modèle de base, avec bras articulés, fermeture à sphère, pour valves 52-1830 - 52-1978

Divaricatore per colonna cervicale, modello base, braccio articolato e chiusura istantanea per valve 52-1830 - 52-1978



**52-1802**

**Cervicaler Sperrer, Basismodell, mit Gelenkarmen aus Peek und Kugelschnellverschluss, für Valven 52-1830 - 52-1978**

Basic cervical retractor, with articulated arms, made of Peek, and ball snap closure, for valves 52-1830 - 52-1978

Separador cervical, modelo básico, con brazos articulados de peek y cierre rápido esférico, para valvas 52-1830 - 52-1978

Ecarteur pour colonne cervicale, modèle de base, avec bras articulés en peek et fermeture à sphère, pour valves 52-1830 - 52-1978

Divaricatore per colonna cervicale, modello base, braccio articolato in peek e chiusura istantanea per valve 52-1830 - 52-1978

Ti = aus Titan, Ti = made of Titanium, Ti = de titanio, Ti = en titane, Ti = in titanio

7\ Ubj YXk N N Y89AC J9FG=CB cZ7 58! ?5G D8 : !9Xlcf fl hd.#k k k 'WX Ug'Wa l'  
 H l g h i hsb mUddYUg l b N YXYa e j Yfglcb H l g h i hWUb VYfYa c j YX'k N N YZ j Yfglcb  
 7\ Ubj YXk N N Y89AC J9FG=CB cZ7 58! ?5G D8 : !9Xlcf fl hd.#k k k 'WX Ug'Wa l'  
 H l g h i hcb mUddYUg l b N YXYa c j Yfglcb H l g h i hWUb VYfYa c j YX'k N N YZ j Yfglcb  
 7\ Ubj YXk N N Y89AC J9FG=CB cZ7 58! ?5G D8 : !9Xlcf fl hd.#k k k 'WX Ug'Wa l'

**Wundspreizer für die cervicale Wirbelsäule**

Retractors for cervical vertebral column  
 Separadores para la columna cervical  
 Ecarteurs pour colonne cervicale  
 Divaricatori per colonna cervicale



**52-1814**  
 20,5 cm, 8"

**Gegensperrer, Basismodell, mit Gelenkarmen (Doppelgelenk) und Kugelschnellverschluss, für Valven 52-1830 - 52-1978**

Basic counter retractor, with articulated arms (double hinge) and ball snap closure, for valves 52-1830 - 52-1978

Contraseparador, modelo básico, con brazos articulados (dobles) y cierre rápido esférico, para valvas 52-1830 - 52-1978

Ecarteur inverse, modèle de base avec bras mobile et fermeture à sphère pour valves 52-1830 - 52-1978

Divaricatore inverso, modello base, braccio mobile e chiusura istantanea per valve 52-1830 - 52-1978



**52-1816**  
 21,0 cm, 8 1/4"

**Gegensperrer, Basismodell, mit Gelenkarmen (Doppelgelenk) aus Peek und Kugelschnellverschluss, für Valven 52-1830 - 52-1978**

Basic counter retractor, with articulated arms (double hinge), made of Peek, and ball snap closure, for valves 52-1830 - 52-1978

Contraseparador, modelo básico, con brazos articulados (dobles) de peek y cierre rápido esférico, para valvas 52-1830 - 52-1978

Ecarteur inverse, modèle de base avec bras articulés (double) en peek et fermeture à sphère pour valves 52-1830 - 52-1978

Divaricatore inverso, modello base, braccio mobile doppio in peek e chiusura istantanea per valve 52-1830 - 52-1978



**52-1804**

**Cervicaler Sperrer, Basismodell, mit Gelenkarmen (Doppelgelenk) und Kugelschnellverschluss, für Valven 52-1830 - 52-1978**

Basic cervical retractor, with articulated arms (double hinge) and ball snap closure, for valves 52-1830 - 52-1978

Separador cervical, modelo básico, con brazos articulados (dobles) y cierre rápido esférico, para valvas 52-1830 - 52-1978

Ecarteur pour colonne cervicale, modèle de base, avec bras articulés (double) et fermeture à sphère, pour valves 52-1830 - 52-1978

Divaricatore cervicale, modello base, braccio mobile doppio chiusura istantanea per valve 52-1830 - 52-1978



**52-1806**

**Cervicaler Sperrer, Basismodell, mit Gelenkarmen (Doppelgelenk) aus Peek und Kugelschnellverschluss, für Valven 52-1830 - 52-1978**

Basic cervical retractor, with articulated arms (double hinge), made of Peek, and ball snap closure, for valves 52-1830 - 52-1978

Separador cervical, modelo básico, con brazos articulados (dobles) de peek y cierre rápido esférico, para valvas 52-1830 - 52-1978

Ecarteur pour colonne cervicale, modèle de base, avec bras articulés (double) en peek et fermeture à sphère, pour valves 52-1830 - 52-1978

Divaricatore cervicale, modello base, braccio mobile doppio in peek, chiusura istantanea per valve 52-1830 - 52-1978



## Wundspreizer für die cervicale Wirbelsäule

Retractors for cervical vertebral column  
 Separadores para la columna cervical  
 Ecarteurs pour colonne cervicale  
 Divaricatori per colonna cervicale

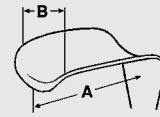

**52-1820**  
 11,5 cm, 4 1/2"

Gegenspreizer, mit Gelenkarmen und Kugelschnellverschluss, für Valven 52-1830 - 52-1978

Counter retractor, with articulated arms and ball snap closure, for valves 52-1830 - 52-1978

Contraseparador con brazos articulados y cierre rápido esférico, para valvas 52-1830 - 52-1978

Ecarteur inverse, modèle de base avec bras articulés et fermeture à sphère pour valves 52-1830 - 52-1978

Divaricatore inverso, modello base, braccio mobile e chiusura istantanea per valve 52-1830 - 52-1978



**52-1822**  
 12,0 cm, 4 3/4"

Gegenspreizer, mit Gelenkarmen aus Peek und Kugelschnellverschluss, für Valven 52-1830 - 52-1978

Counter retractor, with articulated arms, made of Peek, and ball snap closure, for valves 52-1830 - 52-1978

Contraseparador con brazos articulados de peek y cierre rápido esférico, para valvas 52-1830 - 52-1978

Ecarteur inverse, avec bras articulés en peek et fermeture à sphère pour valves 52-1830 - 52-1978

Divaricatore cervicale, modello base, braccio mobile doppio in peek, chiusura istantanea per valve 52-1830 - 52-1978



- 52-1830** 35 x 23 mm (Ax B)
- 52-1831** 40 x 23 mm (Ax B)
- 52-1832** 45 x 23 mm (Ax B)
- 52-1833** 50 x 23 mm (Ax B)
- 52-1834** 55 x 23 mm (Ax B)
- 52-1835** 60 x 23 mm (Ax B)
- 52-1836** 65 x 23 mm (Ax B)
- 52-1837** 70 x 23 mm (Ax B)

Mediale Valven mit Kugelschnellverschluss, für Sperrer 52-1800 - 52-1822

Medial valves with ball snap closure, for retractors 52-1800 - 52-1822

Valvas centrales con cierre rápido esférico, para separadores 52-1800 - 52-1822

Valves centrales avec fermeture à sphère pour ecarteurs 52-1800 - 52-1822

Valve centrali a chiusura istantanea per divaricatori 52-1800 - 52-1822



- 52-1840** 40 x 23 mm (Ax B)
- 52-1841** 45 x 23 mm (Ax B)
- 52-1842** 50 x 23 mm (Ax B)
- 52-1843** 55 x 23 mm (Ax B)
- 52-1844** 60 x 23 mm (Ax B)
- 52-1845** 65 x 23 mm (Ax B)
- 52-1846** 70 x 23 mm (Ax B)

Laterale Valven mit Kugelschnellverschluss, für Sperrer 52-1800 - 52-1822

Lateral valves with ball snap closure, for retractors 52-1800 - 52-1822

Valvas laterales con cierre rápido esférico, para separadores 52-1800 - 52-1822

Valves latérales avec fermeture à sphère pour ecarteurs 52-1800 - 52-1822

Valve laterali a chiusura istantanea per divaricatori 52-1800 - 52-1822



- 52-1850** 40 x 15 mm (Ax B)
- 52-1851** 45 x 15 mm (Ax B)
- 52-1852** 50 x 15 mm (Ax B)
- 52-1853** 55 x 15 mm (Ax B)
- 52-1854** 60 x 15 mm (Ax B)

Laterale Valven mit Kugelschnellverschluss, für Sperrer 52-1800 - 52-1822

Lateral valves with ball snap closure, for retractors 52-1800 - 52-1822

Valvas laterales con cierre rápido esférico, para separadores 52-1800 - 52-1822

Valves latérales avec fermeture à sphère pour ecarteurs 52-1800 - 52-1822

Valve laterali a chiusura istantanea per divaricatori 52-1800 - 52-1822



- 52-1860** 35 x 23 mm (Ax B)
- 52-1861** 40 x 23 mm (Ax B)
- 52-1862** 45 x 23 mm (Ax B)
- 52-1863** 50 x 23 mm (Ax B)
- 52-1864** 55 x 23 mm (Ax B)
- 52-1865** 60 x 23 mm (Ax B)
- 52-1866** 65 x 23 mm (Ax B)
- 52-1867** 70 x 23 mm (Ax B)
- 52-1868** 75 x 23 mm (Ax B)

Stumpfe Valven mit Kugelschnellverschluss, für Sperrer 52-1800 - 52-1822

Blunt valves with ball snap closure, for retractors 52-1800 - 52-1822

Valvas romas con cierre rápido esférico, para separadores 52-1800 - 52-1822

Valves mousées avec fermeture à sphère pour ecarteurs 52-1800 - 52-1822

Valve smusse a chiusura istantanea per divaricatori 52-1800 - 52-1822

**Valven**

Valves  
Valvas  
Valves  
Valve

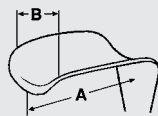

- 52-1870** 40 x 23 mm (AxB)
- 52-1871** 45 x 23 mm (AxB)
- 52-1872** 50 x 23 mm (AxB)
- 52-1873** 55 x 23 mm (AxB)
- 52-1874** 60 x 23 mm (AxB)
- 52-1875** 65 x 23 mm (AxB)
- 52-1876** 75 x 23 mm (AxB)

**Mediale Valven aus Peek mit Kugelschnellverschluss, für Sperrer**  
52-1800 - 52-1822

Medial valves, made of Peek, with ball snap closure, for retractors  
52-1800 - 52-1822

Valvas centrales de peek, con cierre rápido esférico, para separadores  
52-1800 - 52-1822

Valves centrales en peek avec fermeture à sphère pour écarteurs  
52-1800 - 52-1822

Valve centrali in peek a chiusura istantanea per divaricatori 52-1800 - 52-1822



- 52-1880** 40 x 12 mm (AxB)
- 52-1881** 45 x 12 mm (AxB)
- 52-1882** 50 x 12 mm (AxB)
- 52-1883** 55 x 12 mm (AxB)
- 52-1884** 60 x 12 mm (AxB)

**Laterale Valven aus Peek, mit Kugelschnellverschluss, für Sperrer**  
52-1800 - 52-1822

Lateral valves, made of Peek, with ball snap closure, for retractors  
52-1800 - 52-1822

Valvas laterales de peek, con cierre rápido esférico, para separadores  
52-1800 - 52-1822

Valves latérales en peek avec fermeture à sphère pour écarteurs  
52-1800 - 52-1822

Valve laterali in peek a chiusura istantanea per divaricatori 52-1800 - 52-1822



- 52-1890** 40 x 23 mm (AxB)
- 52-1891** 45 x 23 mm (AxB)
- 52-1892** 50 x 23 mm (AxB)
- 52-1893** 55 x 23 mm (AxB)
- 52-1894** 60 x 23 mm (AxB)
- 52-1895** 65 x 23 mm (AxB)
- 52-1896** 75 x 23 mm (AxB)

**Laterale Valven aus Peek, mit Kugelschnellverschluss, für Sperrer**  
52-1800 - 52-1822

Lateral valves, made of Peek, with ball snap closure, for retractors  
52-1800 - 52-1822

Valvas laterales de peek, con cierre rápido esférico, para separadores  
52-1800 - 52-1822

Valves latérales en peek avec fermeture à sphère pour écarteurs 52-1800 - 52-1822

Valve laterali in peek a chiusura istantanea per divaricatori 52-1800 - 52-1822



- 52-1900** 40 x 23 mm (AxB)
- 52-1901** 45 x 23 mm (AxB)
- 52-1902** 50 x 23 mm (AxB)
- 52-1903** 55 x 23 mm (AxB)
- 52-1904** 60 x 23 mm (AxB)
- 52-1905** 65 x 23 mm (AxB)
- 52-1906** 75 x 23 mm (AxB)

**Stumpfe Valven aus Peek, mit Kugelschnellverschluss, für Sperrer**  
52-1800 - 52-1822

Blunt valves, made of Peek, with ball snap closure, for retractors 52-1800 - 52-1822

Valvas romas de peek, con cierre rápido esférico, para separadores  
52-1800 - 52-1822

Valves mousses en peek avec fermeture à sphère pour écarteurs  
52-1800 - 52-1822

Valve smusse in peek a chiusura istantanea per divaricatori 52-1800 - 52-1822

7\ Ubj YX'k N 'N Y'89AC'J9FG=CB'cZ7 58! ?5G'D8: !9Xlcf'fl hhd.#k k k 'WDX Ug'Wca r'  
H l'g'hl hcb mUddYUg'p'N Y'XYa e'j Yfglcb" H l'g'hl hWUb'VY'fYa e'j YX'k N 'N Y'Z "j Yfglcb"  
7\ Ubj YX'k N 'N Y'89AC'J9FG=CB'cZ7 58! ?5G'D8: !9Xlcf'fl hhd.#k k k 'WDX Ug'Wca r'  
H l'g'hl hcb mUddYUg'p'N Y'XYa e'j Yfglcb" H l'g'hl hWUb'VY'fYa e'j YX'k N 'N Y'Z "j Yfglcb"  
7\ Ubj YX'k N 'N Y'89AC'J9FG=CB'cZ7 58! ?5G'D8: !9Xlcf'fl hhd.#k k k 'WDX Ug'Wca r'





**Valven**  
Valves  
Valvas  
Valves  
Valve

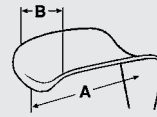

- ▶ **52-1910** 40 x 20 mm (AxB)
- 52-1911** 45 x 20 mm (AxB)
- 52-1912** 50 x 20 mm (AxB)
- 52-1913** 55 x 20 mm (AxB)
- 52-1914** 60 x 20 mm (AxB)
- 52-1915** 65 x 20 mm (AxB)
- 52-1916** 70 x 20 mm (AxB)
- 52-1917** 75 x 20 mm (AxB)

**Mediale Valven aus Titan, mit Kugelschnellverschluss, für Sperrer 52-1800 - 52-1822**

Medial valves, made of Titanium, with ball snap closure, for retractors 52-1800 - 52-1822

Valvas centrales de titanio, con cierre rápido esférico, para separadores 52-1800 - 52-1822

Valves centrales en titane avec fermeture à sphère pour écarteurs 52-1800 - 52-1822

Valve centrali in titanio a chiusura istantanea per divaricatori 52-1800 - 52-1822



- 52-1920** 25 x 20 mm (AxB)
- 52-1921** 30 x 20 mm (AxB)
- 52-1922** 35 x 20 mm (AxB)
- ▶ **52-1923** 40 x 20 mm (AxB)
- 52-1924** 45 x 20 mm (AxB)
- 52-1925** 50 x 20 mm (AxB)
- 52-1926** 55 x 20 mm (AxB)
- 52-1927** 60 x 20 mm (AxB)
- 52-1928** 65 x 20 mm (AxB)
- 52-1929** 70 x 20 mm (AxB)
- 52-1930** 75 x 20 mm (AxB)

**Laterale Valven aus Titan, mit Kugelschnellverschluss, für Sperrer 52-1800 - 52-1822**

Lateral valves, made of Titanium, with ball snap closure, for retractors 52-1800 - 52-1822

Valvas laterales de titanio, con cierre rápido esférico, para separadores 52-1800 - 52-1822

Valves latérales en titane avec fermeture à sphère pour écarteurs 52-1800 - 52-1822

Valve laterali in titanio a chiusura istantanea per divaricatori 52-1800 - 52-1822



- 52-1940** 30 x 20 mm (AxB)
- 52-1941** 35 x 20 mm (AxB)
- ▶ **52-1942** 40 x 20 mm (AxB)
- 52-1943** 45 x 20 mm (AxB)
- 52-1944** 50 x 20 mm (AxB)
- 52-1945** 55 x 20 mm (AxB)
- 52-1946** 60 x 20 mm (AxB)
- 52-1947** 65 x 20 mm (AxB)
- 52-1948** 70 x 20 mm (AxB)
- 52-1949** 75 x 20 mm (AxB)

**Stumpfe Valven aus Titan, mit Kugelschnellverschluss, für Sperrer 52-1800 - 52-1822**

Blunt valves, made of Titanium, with ball snap closure, for retractors 52-1800 - 52-1822

Valvas romas de titanio, con cierre rápido esférico, para separadores 52-1800 - 52-1822

Valves mousses en titane avec fermeture à sphère pour écarteurs 52-1800 - 52-1822

Valve smusse in titanio a chiusura istantanea per divaricatori 52-1800 - 52-1822



- 52-1950** 35 x 20 mm (AxB)
- 52-1951** 40 x 20 mm (AxB)
- ▶ **52-1952** 45 x 20 mm (AxB)
- 52-1953** 50 x 20 mm (AxB)
- 52-1954** 55 x 20 mm (AxB)
- 52-1955** 60 x 20 mm (AxB)
- 52-1956** 65 x 20 mm (AxB)
- 52-1957** 70 x 20 mm (AxB)

**Mediale Valven aus Titan, mit Kugelschnellverschluss, für Sperrer 52-1800 - 52-1822**

Medial valves, made of Titanium, with ball snap closure, for retractors 52-1800 - 52-1822

Valvas centrales de titanio, con cierre rápido esférico, para separadores 52-1800 - 52-1822

Valves centrales en titane avec fermeture à sphère pour écarteurs 52-1800 - 52-1822

Valve centrali in titanio a chiusura istantanea per divaricatori 52-1800 - 52-1822



- 52-1960** 25 x 20 mm (AxB)
- 52-1961** 30 x 20 mm (AxB)
- 52-1962** 35 x 20 mm (AxB)
- ▶ **52-1963** 40 x 20 mm (AxB)
- 52-1964** 45 x 20 mm (AxB)
- 52-1965** 50 x 20 mm (AxB)
- 52-1966** 55 x 20 mm (AxB)
- 52-1967** 60 x 20 mm (AxB)
- 52-1968** 65 x 20 mm (AxB)
- 52-1969** 70 x 20 mm (AxB)

**Laterale Valven aus Titan, mit Kugelschnellverschluss, für Sperrer 52-1800 - 52-1822**

Lateral valves, made of Titanium, with ball snap closure, for retractors 52-1800 - 52-1822

Valvas laterales de titanio, con cierre rápido esférico, para separadores 52-1800 - 52-1822

Valves latérales en titane avec fermeture à sphère pour écarteurs 52-1800 - 52-1822

Valve laterali in titanio a chiusura istantanea per divaricatori 52-1800 - 52-1822



- 52-1970** 35 x 20 mm (AxB)
- 52-1971** 40 x 20 mm (AxB)
- 52-1972** 45 x 20 mm (AxB)
- ▶ **52-1973** 50 x 20 mm (AxB)
- 52-1974** 55 x 20 mm (AxB)
- 52-1975** 60 x 20 mm (AxB)
- 52-1976** 65 x 20 mm (AxB)
- 52-1977** 70 x 20 mm (AxB)
- 52-1978** 75 x 20 mm (AxB)

**Stumpfe Valven aus Titan, mit Kugelschnellverschluss, für Sperrer 52-1800 - 52-1822**

Blunt valves, made of Titanium, with ball snap closure, for retractors 52-1800 - 52-1822

Valvas romas de titanio, con cierre rápido esférico, para separadores 52-1800 - 52-1822

Valves mousses en titane avec fermeture à sphère pour écarteurs 52-1800 - 52-1822

Valve smusse in titanio a chiusura istantanea per divaricatori 52-1800 - 52-1822

▶ Photo shows this instrument.

**Wundspreizer für die cervicale Wirbelsäule**

Retractors for cervical vertebral column

Separadores para la columna cervical

Ecarteurs pour colonne cervicale

Divaricatori per colonna cervicale

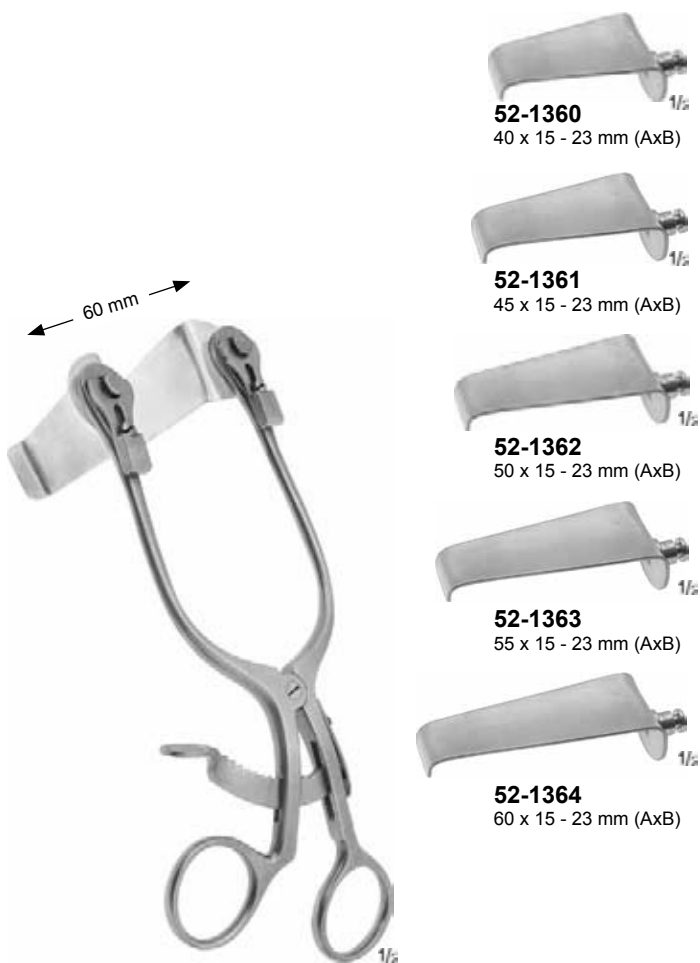
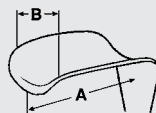

**CLOWARD**

**52-1355**

17,0 cm, 6 3/4"

Wundspreizer, komplett, bestehend aus:

- 52-1356 1 Sperrer
- 52-1360 1 stumpfen Seitenvalve 40 x 15 - 23 mm
- 52-1361 1 stumpfen Seitenvalve 45 x 15 - 23 mm
- 52-1362 1 stumpfen Seitenvalve 50 x 15 - 23 mm
- 52-1363 1 stumpfen Seitenvalve 55 x 15 - 23 mm
- 52-1364 1 stumpfen Seitenvalve 60 x 15 - 23 mm

Self-retaining retractor, complete, consisting of:

- 52-1356 1 spreader
- 52-1360 1 lateral valve, blunt 40 x 15 - 23 mm
- 52-1361 1 lateral valve, blunt 45 x 15 - 23 mm
- 52-1362 1 lateral valve, blunt 50 x 15 - 23 mm
- 52-1363 1 lateral valve, blunt 55 x 15 - 23 mm
- 52-1364 1 lateral valve, blunt 60 x 15 - 23 mm

Separador autostático, completo, compuesto de:

- 52-1356 1 separador
- 52-1360 1 valva lateral, roma 40 x 15 - 23 mm
- 52-1361 1 valva lateral, roma 45 x 15 - 23 mm
- 52-1362 1 valva lateral, roma 50 x 15 - 23 mm
- 52-1363 1 valva lateral, roma 55 x 15 - 23 mm
- 52-1364 1 valva lateral, roma 60 x 15 - 23 mm

Ecarteur, complet, composé de:

- 52-1356 1 ecarteur
- 52-1360 1 valve latérale mousse 40 x 15 - 23 mm
- 52-1361 1 valve latérale mousse 45 x 15 - 23 mm
- 52-1362 1 valve latérale mousse 50 x 15 - 23 mm
- 52-1363 1 valve latérale mousse 55 x 15 - 23 mm
- 52-1364 1 valve latérale mousse 60 x 15 - 23 mm

Divaricatore, completo, composto da:

- 52-1356 1 divaricatore
- 52-1360 1 valva laterale smussa 40 x 15 - 23 mm
- 52-1361 1 valva laterale smussa 45 x 15 - 23 mm
- 52-1362 1 valva laterale smussa 50 x 15 - 23 mm
- 52-1363 1 valva laterale smussa 55 x 15 - 23 mm
- 52-1364 1 valva laterale smussa 60 x 15 - 23 mm

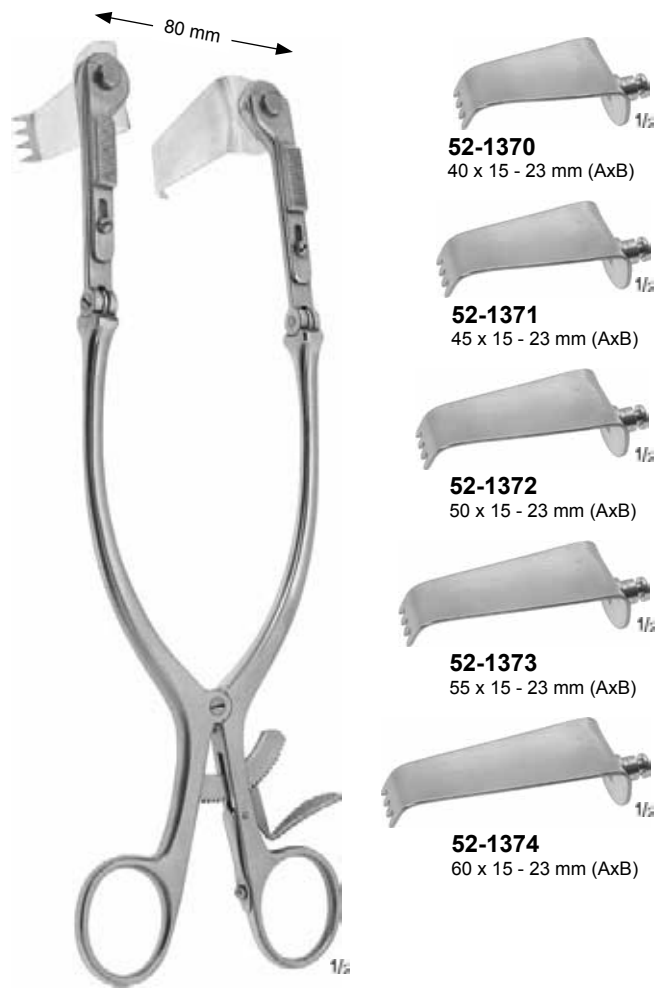

**CLOWARD**

**52-1345**

25,0 cm, 10"

Wundspreizer, komplett, bestehend aus:

- 52-1346 1 Sperrer
- 52-1370 1 gezahnten Seitenvalve 40 x 15 - 23 mm
- 52-1371 1 gezahnten Seitenvalve 45 x 15 - 23 mm
- 52-1372 1 gezahnten Seitenvalve 50 x 15 - 23 mm
- 52-1373 1 gezahnten Seitenvalve 55 x 15 - 23 mm
- 52-1374 1 gezahnten Seitenvalve 60 x 15 - 23 mm

Self-retaining retractor, complete, consisting of:

- 52-1346 1 spreader
- 52-1370 1 lateral valve, serrated 40 x 15 - 23 mm
- 52-1371 1 lateral valve, serrated 45 x 15 - 23 mm
- 52-1372 1 lateral valve, serrated 50 x 15 - 23 mm
- 52-1373 1 lateral valve, serrated 55 x 15 - 23 mm
- 52-1374 1 lateral valve, serrated 60 x 15 - 23 mm

Separador autostático, completo, compuesto de:

- 52-1346 1 separador
- 52-1370 1 valva lateral, dentada 40 x 15 - 23 mm
- 52-1371 1 valva lateral, dentada 45 x 15 - 23 mm
- 52-1372 1 valva lateral, dentada 50 x 15 - 23 mm
- 52-1373 1 valva lateral, dentada 55 x 15 - 23 mm
- 52-1374 1 valva lateral, dentada 60 x 15 - 23 mm

Ecarteur, complet, composé de:

- 52-1346 1 ecarteur
- 52-1370 1 valve latérale dentée 40 x 15 - 23 mm
- 52-1371 2 valve latérale dentée 45 x 15 - 23 mm
- 52-1372 3 valve latérale dentée 50 x 15 - 23 mm
- 52-1373 4 valve latérale dentée 55 x 15 - 23 mm
- 52-1374 5 valve latérale dentée 60 x 15 - 23 mm

Divaricatore, completo, composto da:

- 52-1346 1 divaricatore
- 52-1370 1 valva laterale dentata 40 x 15 - 23 mm
- 52-1371 1 valva laterale dentata 45 x 15 - 23 mm
- 52-1372 1 valva laterale dentata 50 x 15 - 23 mm
- 52-1373 1 valva laterale dentata 55 x 15 - 23 mm
- 52-1374 1 valva laterale dentata 60 x 15 - 23 mm

7\ Ubj YX'k N 'N Y'89AC'J9FG=CB'cZ7 58! ?5G'D8: !9Xlcf'fl Hd.#k k k 'WX Ug'Wa r'  
 H l'g'hl hcb'mUddYUg'p'N Y'XYa e'j Yfglcb"H l'g'hl hWUb'VY'fYa e'j YX'k N 'N Y'Z "j Yfglcb"  
 7\ Ubj YX'k N 'N Y'89AC'J9FG=CB'cZ7 58! ?5G'D8: !9Xlcf'fl Hd.#k k k 'WX Ug'Wa r'  
 H l'g'hl hcb'mUddYUg'p'N Y'XYa e'j Yfglcb"H l'g'hl hWUb'VY'fYa e'j YX'k N 'N Y'Z "j Yfglcb"  
 7\ Ubj YX'k N 'N Y'89AC'J9FG=CB'cZ7 58! ?5G'D8: !9Xlcf'fl Hd.#k k k 'WX Ug'Wa r'



### Wundspreizer für die cervicale Wirbelsäule

Retractors for cervical vertebral column  
Separadores para la columna cervical  
Ecarteurs pour colonne cervicale  
Divaricatori per colonna cervicale



**52-0991**  
19,0 cm, 7 1/2"

**Gegensperrer, Basismodell, mit Gelenkarmen (Doppelgelenk) und Kugelschnellverschluss, für Valven 52-0940 - 52-0988**

Basic counter retractor, with articulated arms (double hinge) and ball snap closure, for valves 52-0940 - 52-0988

Contraseparador, modelo básico, con brazos articulados (dobles) y cierre rápido esférico, para valvas 52-0940 - 52-0988

Ecarteur inverse, modèle de base avec bras articulés (double) et fermeture à sphère pour valves 52-0940 - 52-0988

Divaricatore inverso, modello base, con braccio mobile doppio e chiusura istantanea per valve 52-0940 - 52-0988



**52-0990**

**Cervicaler Sperrer, Basismodell, mit Gelenkarmen (Doppelgelenk) und Kugelschnellverschluss für Valven 52-0940 - 52-0988**

Basic cervical retractor, with articulated arms (double hinge) and ball snap closure, for valves 52-0940 - 52-0988

Separador cervical, modelo básico, con brazos articulados (dobles) y cierre rápido esférico, para valvas 52-0940 - 52-0988

Ecarteur pour colonne vertébrale, modèle de base, avec bras articulés (double), fermeture à sphère, pour valves 52-0940 - 52-0988

Divaricatore cervicale, modello base con braccio mobile doppio e chiusura istantanea per valve 52-0940 - 52-0988



**52-0992**  
11,5 cm, 4 1/2"

**Gegensperrer mit Gelenkarmen und Kugelschnellverschluss, für Valven 52-0940 - 52-0988**

Counter retractor with articulated arms and ball snap closure, for valves 52-0940 - 52-0988

Contraseparador con brazos articulados y cierre rápido esférico, para valvas 52-0940 - 52-0988

Ecarteur inverse avec bras articulés et fermeture à sphère pour valves 52-0940 - 52-0988

Divaricatore inverso con braccio mobile e chiusura istantanea per valve 52-0940 - 52-0988



**52-0903**  
18,5 cm, 7 1/4"

**Handgriff mit Kugelschnellverschluss für Valven 52-0940 - 52-0988**

Handle with ball snap closure, for valves 52-0940 - 52-0988

Mango con cierre rápido esférico, para valvas 52-0940 - 52-0988

Manche avec fermeture à sphère pour valves 52-0940 - 52-0988

Manico a chiusura istantanea per valve 52-0940 - 52-0988

7\ Ubj YX'k N 'N Y'89AC'J9FG=CB'cZ7 58! ?5G'D8 : !9Xlcf'fl hhd.#k k k 'WX Ug'Wa r'  
H l g'hl hsb mUddYUg'p'N YXYa e'j Yfglcb" H l g'hl hwb'vYfYa e j YX'k N 'N YZ ""j Yfglcb"  
7\ Ubj YX'k N 'N Y'89AC'J9FG=CB'cZ7 58! ?5G'D8 : !9Xlcf'fl hhd.#k k k 'WX Ug'Wa r'  
H l g'hl hcb mUddYUg'p'N YXYa c'j Yfglcb" H l g'hl hwb'vYfYa c j YX'k N 'N YZ ""j Yfglcb"  
7\ Ubj YX'k N 'N Y'89AC'J9FG=CB'cZ7 58! ?5G'D8 : !9Xlcf'fl hhd.#k k k 'WX Ug'Wa r'

**Valven**

Valves  
Valvas  
Valves  
Valves  
Valve

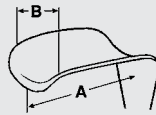

- 52-0940** 25 x 19 mm (AxB)
- 52-0941** 30 x 19 mm (AxB)
- 52-0942** 35 x 19 mm (AxB)
- 52-0943** 40 x 19 mm (AxB)
- 52-0944** 45 x 19 mm (AxB)
- 52-0945** 50 x 19 mm (AxB)
- 52-0946** 55 x 19 mm (AxB)
- ▶ **52-0947** 60 x 19 mm (AxB)

**Mediale / laterale Valven aus Titan mit Kugelschnellverschluss, für Sperrer 52-0990 - 52-0992 und Griff 52-0903**

Medial / lateral valves, made of Titanium, with ball snap closure, for retractors 52-0990 - 52-0992 and handle 52-0903

Valvas centrales / laterales de titanio, con cierre rápido esférico, para separadores 52-0990 - 52-0992 y mango 52-0903

Valves centrales/ laterales en titane avec fermeture à sphère pour écarteurs 52-0990 - 52-0992 et manche 52-0903

Valve centrali / laterali in titanio a chiusura istantanea per divaricatori 52-0990 - 52-0992 e manico 52-0903



- 52-0950** 25 x 19 mm (AxB)
- 52-0951** 30 x 19 mm (AxB)
- 52-0952** 35 x 19 mm (AxB)
- 52-0953** 40 x 19 mm (AxB)
- ▶ **52-0954** 45 x 19 mm (AxB)
- 52-0955** 50 x 19 mm (AxB)
- 52-0956** 55 x 19 mm (AxB)
- 52-0957** 60 x 19 mm (AxB)

**Longitudinal Valven aus Titan, mit Kugelschnellverschluss, für Sperrer 52-0990 - 52-0992 und Griff 52-0903**

Longitudinal valves of Titanium, with ball snap closure, for retractors 52-0990 - 52-0992 and handle 52-0903

Valvas longitudinales de Titanio, con cierre rápido esférico, para separadores 52-0990 - 52-0992 y mango 52-0903

Valves longitudinales en titane avec fermeture à sphère pour écarteurs 52-0990 - 52-0992 et manche 52-0903

Valve longitudinali in titanio a chiusura istantanea per divaricatori 52-0990 - 52-0992 e manico 52-0903



- 52-0970** 30 x 24 mm (AxB)
- 52-0971** 35 x 24 mm (AxB)
- ▶ **52-0972** 40 x 24 mm (AxB)
- 52-0973** 45 x 24 mm (AxB)
- 52-0974** 50 x 24 mm (AxB)
- 52-0975** 55 x 24 mm (AxB)
- 52-0976** 60 x 24 mm (AxB)
- 52-0977** 65 x 24 mm (AxB)
- 52-0978** 70 x 24 mm (AxB)

**Mediale Valven aus Titan, mit Kugelschnellverschluss, für Sperrer 52-0990 - 52-0992 und Griff 52-0903**

Medial valves of Titanium, with ball snap closure, for retractors 52-0990 - 52-0992 and handle 52-0903

Valvas centrales de titanio, con cierre rápido esférico, para separadores 52-0990 - 52-0992 y mango 52-0903

Valves centrales en titane avec fermeture à sphère pour écarteurs 52-0990 - 52-0992 et manche 52-0903

Valve centrali in titanio a chiusura istantanea per divaricatori 52-0990 - 52-0992 e manico 52-0903



- 52-0960** 30 x 24 mm (AxB)
- 52-0961** 35 x 24 mm (AxB)
- ▶ **52-0962** 40 x 24 mm (AxB)
- 52-0963** 45 x 24 mm (AxB)
- 52-0964** 50 x 24 mm (AxB)
- 52-0965** 55 x 24 mm (AxB)
- 52-0966** 60 x 24 mm (AxB)
- 52-0967** 65 x 24 mm (AxB)
- 52-0968** 70 x 24 mm (AxB)

**Laterale Valven aus Titan, mit Kugelschnellverschluss, für Sperrer 52-0990 - 52-0992 und Griff 52-0903**

Lateral valves of Titanium, with ball snap closure, for retractors 52-0990 - 52-0992 and handle 52-0903

Valvas laterales de titanio, con cierre rápido esférico, para separadores 52-0990 - 52-0992 y mango 52-0903

Valves latérales en titane avec fermeture à sphère pour écarteurs 52-0990 - 52-0992 et manche 52-0903

Valve laterali in titanio a chiusura istantanea per divaricatori 52-0990 - 52-0992 e manico 52-0903



- 52-0980** 35 x 24 mm (AxB)
- ▶ **52-0981** 40 x 24 mm (AxB)
- 52-0982** 45 x 24 mm (AxB)
- 52-0983** 50 x 24 mm (AxB)
- 52-0984** 55 x 24 mm (AxB)
- 52-0985** 60 x 24 mm (AxB)
- 52-0986** 65 x 24 mm (AxB)
- 52-0987** 70 x 24 mm (AxB)
- 52-0988** 75 x 24 mm (AxB)

**Longitudinal Valven aus Titan, mit Kugelschnellverschluss, für Sperrer 52-0990 - 52-0992 und Griff 52-0903**

Longitudinal valves of Titanium, with ball snap closure, for retractors 52-0990 - 52-0992 and handle 52-0903

Valvas longitudinales de titanio, con cierre rápido esférico, para separadores 52-0990 - 52-0992 y mango 52-0903

Valves longitudinales en titane avec fermeture à sphère pour écarteurs 52-0990 - 52-0992 et manche 52-0903

Valve longitudinali in titanio a chiusura istantanea per divaricatori 52-0990 - 52-0992 e manico 52-0903



**Wundspreizer für die lumbale Wirbelsäule**  
 Retractors for lumbar vertebral column  
 Separadores para la cirugía de la columna lumbar  
 Ecarteurs pour colonne vertébrale lombaire  
 Divaricatori per colonna lombare vertebrale

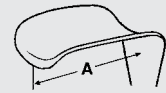

**Oberfläche geschwärzt**  
 Surface black-finish  
 Superficie negra  
 Surface noire  
 Superficie nera



**52-0802**  
40 mm (A)



**52-0803**  
45 mm (A)



**52-0804**  
50 mm (A)



**52-0805**  
55 mm (A)



**52-0806**  
60 mm (A)



**52-0807**  
65 mm (A)

**CASPAR**  
**52-0800**

**Wundspreizer mit Gelenkarmen und Kugelschnellverschluss, komplett, bestehend aus:**  
 52-0801 1 Rahmen  
 52-0802 1 Seitenvalve 40 mm  
 52-0803 1 Seitenvalve 45 mm  
 52-0804 1 Seitenvalve 50 mm  
 52-0805 1 Seitenvalve 55 mm  
 52-0806 1 Seitenvalve 60 mm  
 52-0807 1 Seitenvalve 65 mm

**Self-retaining retractor with articulated arms and ball snap closure, complete, consisting of:**  
 52-0801 1 frame  
 52-0802 1 lateral valve 40 mm  
 52-0803 1 lateral valve 45 mm  
 52-0804 1 lateral valve 50 mm  
 52-0805 1 lateral valve 55 mm  
 52-0806 1 lateral valve 60 mm  
 52-0807 1 lateral valve 65 mm

**Separador autostático con brazos articulados y cierre rápido esférico, completo, compuesto de:**  
 52-0801 1 bastidor  
 52-0802 1 valva lateral 40 mm  
 52-0803 1 valva lateral 45 mm  
 52-0804 1 valva lateral 50 mm  
 52-0805 1 valva lateral 55 mm  
 52-0806 1 valva lateral 60 mm  
 52-0807 1 valva lateral 65 mm

**Ecarteur avec bras articulés, fermeture à sphère, complet, composé de:**  
 52-0801 1 cadre  
 52-0802 1 valve latérale 40 mm  
 52-0803 1 valve latérale 45 mm  
 52-0804 1 valve latérale 50 mm  
 52-0805 1 valve latérale 55 mm  
 52-0806 1 valve latérale 60 mm  
 52-0807 1 valve latérale 65 mm

**Divaricatore con braccio articolato a chiusura istantanea, completo, composto da:**  
 52-0801 1 telaio  
 52-0802 1 valva laterale 40 mm  
 52-0803 1 valva laterale 45 mm  
 52-0804 1 valva laterale 50 mm  
 52-0805 1 valva laterale 55 mm  
 52-0806 1 valva laterale 60 mm  
 52-0807 1 valva laterale 65 mm

7\ Ubj YX'k N N Y'89AC J9FG=CB cZ7 58! ?5G'D8 : I9Xlcf' fl hd.#k k k 'WX Ug'Wa r'  
 H jg'hl hsb mUddYUg' b'N YXYa e' j Yfglcb" H jg'hl hwb' VYfYa c j YX'k N N YZ " j Yfglcb"  
 7\ Ubj YX'k N N Y'89AC J9FG=CB cZ7 58! ?5G'D8 : I9Xlcf' fl hd.#k k k 'WX Ug'Wa r'  
 H jg'hl hcb mUddYUg' b'N YXYa c' j Yfglcb" H jg'hl hwb' VYfYa c j YX'k N N YZ " j Yfglcb"  
 7\ Ubj YX'k N N Y'89AC J9FG=CB cZ7 58! ?5G'D8 : I9Xlcf' fl hd.#k k k 'WX Ug'Wa r'